



INOX  TYLE



INDEX

Introduction

FROM LUXURY BOATING - *p 002*
TO SWIMMING POOLS AND
GARDENS

HIGH-QUALITY MATERIALS - *p 004*
AND ARTISANSHIP

Showers

INTERLUDE - *p 008*

MOTIVO - *p 014*

ARIA - *p 018*

PRELUDIO - *p 024*

MELODY - *p 028*

ARMONIA - *p 036*

YACHT - *p 042*

RIVA - *p 046*

FLORIDA - *p 050*

AURORA - *p 052*

TECNO - *p 062*

TECNO CUBE - *p 066*

TECNO CUBE SQUARE - *p 070*

TECNO CUBE 100 - *p 072*

Fountains

NIAGARA - *p 080*

NIAGARA CUBE - *p 084*

NIAGARA RIO - *p 086*

COLORADO - *p 088*

BIRDY - *p 092*

TELEPHONE - *p 096*

SHUT OFF - *p 102*

SHUT OFF CUBE - *p 104*

PELLICANO - *p 106*

PELLICANO DUO - *p 110*

PELLICANO CUBE - *p 112*

Archways

BROOKLYN - *p 116*

CUBE - *p 120*

RUBINO - *p 122*

FROM LUXURY BOATING TO SWIMMING POOLS AND GARDENS

ARTISANAL CREATIONS, IN STEEL,
THAT LAST

This is the story of a group of Italian artisans sharing the passion for navigation and the sea. We are specialized in the production of accessories and equipments for luxury boating. A leading edge sector in Tuscany, especially in Versilia, that requires very specific technical skills and distinct artistic sensibility.

Creating products for luxury yachts means balancing attention to beauty and style with quality of materials and processes.

Our creations are all weatherized and are able to preserve their aesthetic and functional characteristics over time.

Versilia has always been a land of men able to look beyond the horizon with optimism in search of new opportunities. These experiences led to the idea of bringing ashore the artisanal passion for beautifully crafted and durable objects, which can decorate and enhance swimming pools and the most enchanting gardens.

Inoxstyle creates objects, unique in its genre, characterized by simple lines but at the same time elegant and sophisticated.

Artisanal creations, in steel, that last.

UNIQUE PRODUCTS FOR UNIQUE SPACES

We constantly work with the most esteemed architects and designers to be able to deliver unique products, which can be recognized and appreciated.

Co-design

We have developed co-design services ranging from custom drawing to joint design, specifically with designers and architects.

Customization

The products from the catalogue can be customized according to our customers' wishes. For example: logos or aesthetic elements engraving, coordinated with the space where the object is placed; decorative lighting.

Service and Maintenance

Naturally, such high quality products are supported by a service characterized by great efficiency and availability.



INOX
TYLE

HIGH-QUALITY MATERIALS AND ARTISANSHIP

UNRIVALED BEAUTY

Beauty, quality, uniqueness and durability. We base our products on these values. The showers design is unique and exclusive, developed in collaboration with architects and designers in order to deliver innovative and elegant products. The material is always and only **AISI 316L stainless steel**, in both body and screws.

Quality, durability and resistance to environmental agents are guaranteed because the oxidizable components are completely eliminated. The objects are made in a **single piece**. No block assembly or junctions. The absence of sharp edges, exposed to atmospheric elements, ensures sturdiness and durability, even in the most difficult environmental conditions, e.g. in the presence of brackish and chlorine. **Exposed screws are reduced to a minimum**. It is an aesthetic choice, which favors beauty, but also a functional choice to prevent oxidation, limestone or rust deposits.

Each object is treated with **mirror-like polishing, "Nautical" quality, manually done**. This technique makes it glossier, therefore more aesthetically appealing, and provides a longer durability being less susceptible to external agents. We use **top quality Italian hydraulic components**.

Each showerhead utilizes silicone rubber. This makes cleaning very easy due to the absence of limestone clogging. Each product can be equipped with **electronic faucet** with a timer function, to adjust the duration of the water stream. Aesthetically modern and pleasant, anti-tampering, enhanced by the pleasant hydro-massage function.

To facilitate the storage during the winter months, on many models we have implemented the option of a **quick connection base** to move the showers more easily. It also provides greater anti-vandal safety. We are open to the demands and needs of each customer. You can **customize** each model, change a few technical features or make incisions, even for lighting, in the body of the product.

LET'S DISCOVER
TOGETHER ALL THE
INOXSTYLE MODELS
FEATURES:

The design is unique and exclusive.

*The material is always and only
AISI 316L stainless steel.*

*The objects are made in a single
piece.*

*Exposed screws are reduced to a
minimum.*

*Each object is treated with mirror-
like polishing, "Nautical" quality,
manually done.*

*We use top quality Italian hydraulic
components.*

*Each showerhead utilizes silicone
rubber.*

*The faucet is electronic with a timer
function.*

*You can customize the body of each
shower and of each product with
engraved and illuminated writing.*





INTERLUDE
MOTIVO
ARIA
PRELUDIO
MELODY
ARMONIA

SOUNDS PERFECT





INTERLUDE

Outdoor shower. A shower with a single arched arm, with a rectangular cross section, with double recessed showerheads. Also available in a two arched arms version, with a rectangular cross section, opposite to each other, each with double recessed showerheads.

AESTHETIC and FUNCTIONAL CHARACTERISTICS

Shower completely made of AISI 316L stainless steel, in both body and screws.

Mirror-like polishing (“Nautical” quality, manually done): less vulnerable to the elements.

Product made in a single piece: no block assembly or junctions.

Showerhead with silicone rubber: anti-limestone and anti-obstruction.

Optional auxiliary water output with ½” metal nozzle.

UNIQUE ELEMENTS

Electronic faucet *with timer and hydro-massage functions. Aesthetically pleasant and anti-tampering.*

Dual showerhead *recessed into the shower body.*

Customization *(text or logos, lights) is possible upon request.*





INTERLUDE

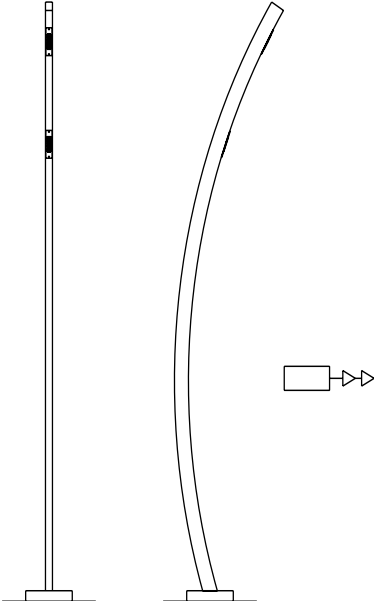

Cod: 01.024

Name: Interlude shower

Description: Single arched arm, with a rectangular cross section, with dual showerheads.

Standard Configuration

2 showerheads - Body 60x30 mm

Showerhead on side 30 mm

Faucet: “Genius” electronic faucet [cod. 51.200]

Showerhead: Showerhead recessed into the body

Mounting: Visible technical screws

Measurements: Main body 30x60 mm, h 230 mm

Showerhead h 170 and 210 mm

Base 200x200 mm, h 40 mm

Materials: AISI 316L stainless steel, quick connection coupling system

Finish: Glossy, mirror-like manual polishing, “nautical” level quality

Hook-up: Water input 1/2”

Extra: Photocells columns

Alternative Faucets

- Mixer on external column h 80 cm 60x60 mm [cod. 51.011]
- “Stella” faucet on external column h 80 cm 60x60 mm [cod. 51.012]
- Floor mounted timed flow faucet [cod. 51.004]
- Timed flow faucet (on external column h 80 cm 60x60 mm) [cod. 51.013]

Options

- Satin finish [cod. 55.001]
- Telephone showerhead [cod. 53.001]
- Water service output 1/2” [cod. 56.001]

INTERLUDE



INTERLUDE DUPLÉ

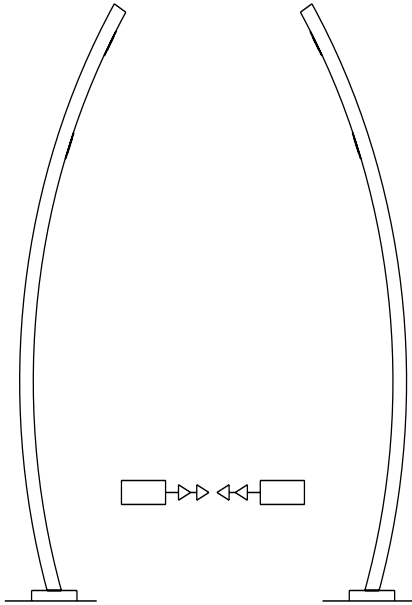

Cod: 01.054

Name: Interlude duple shower

Description: Shower with two arched arms, with a rectangular cross section, opposite to each other, each with a double recessed showerhead

Standard Configuration

Double body with 2 recessed showerheads
Body 60x30 mm showerhead on the side 30 mm

Faucet: “Genius” electronic faucet [cod. 51.200]

Showerhead: Showerhead recessed into the shower body

Mounting: Visible technical screws

Measurements: Main body 30x60 mm, h 230 cm

Showerhead height 170 and 210 cm

Base 200x200 mm, h 40 mm

Materials: AISI 316L stainless steel, quick connection coupling system

Finish: Glossy, mirror-like manual polishing, “nautical” level quality

Hook-up: Water input 1/2”

Extra: Photocells columns

Alternative Faucets

- Mixer on external column h80 cm 60x60 mm [cod. 51.011]
- “Stella” faucet on external column h80 cm 60x60 mm [cod. 51.012]
- Floor-mounted timed flow faucet [cod. 51.004]
- Timed flow faucet on external column h80 cm 60x60 mm [cod. 51.013]

Options

- Satin finish [cod. 55.001]
- Telephone showerhead [cod. 53.001]
- Water service output 1/2” [cod. 56.001]

INTERLUDE DUPLÉ

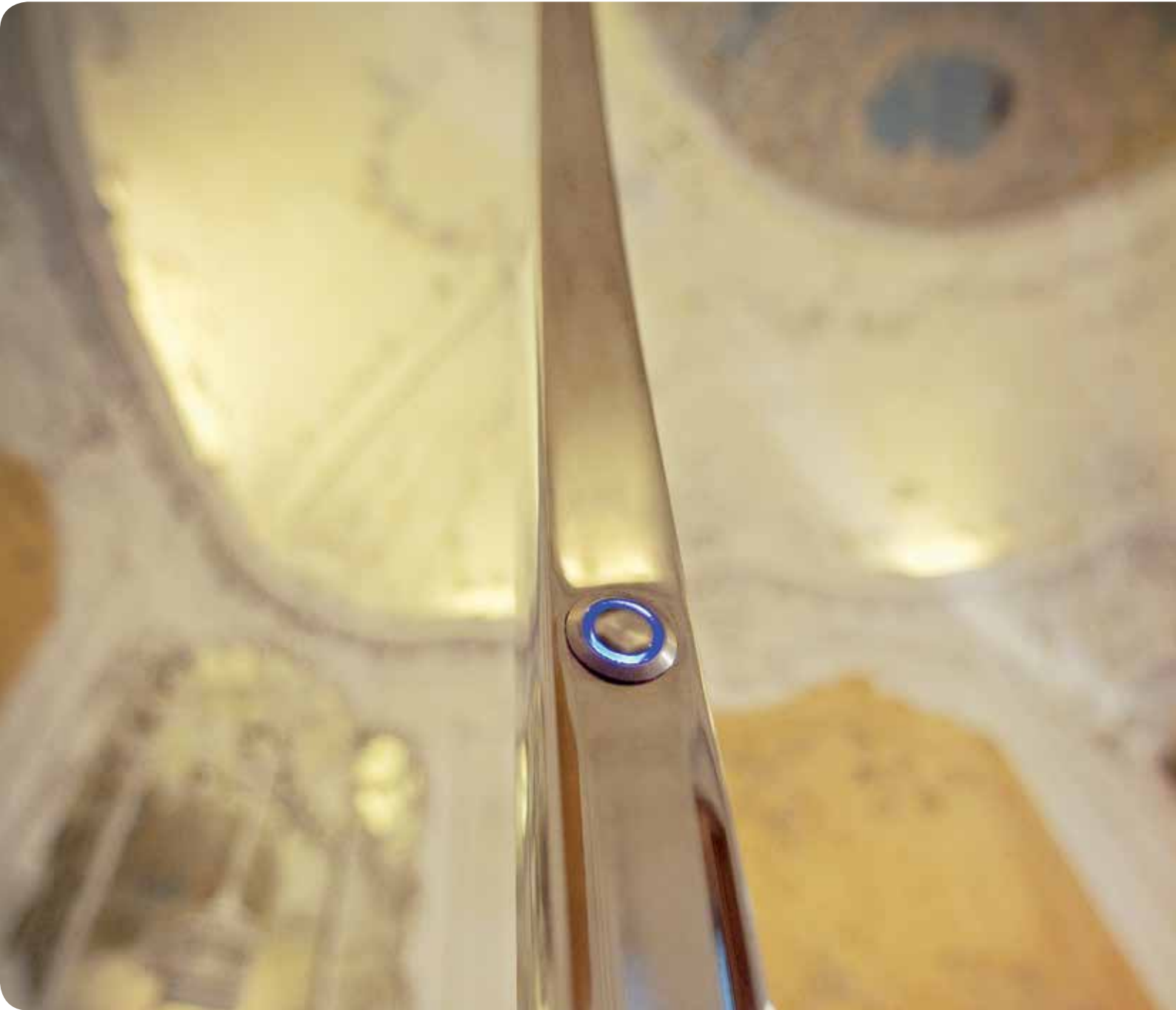

MOTIVO

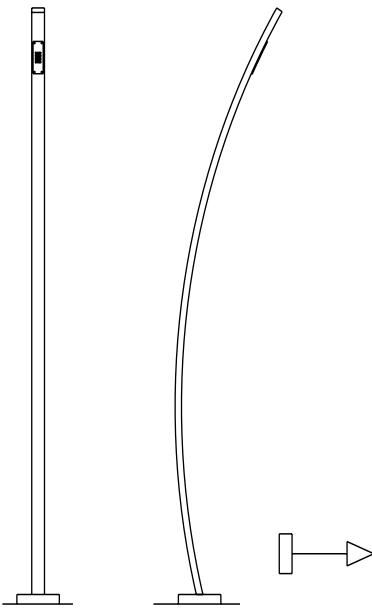

Cod: 01.052

Name: Motivo shower

Description: Shower with a single arched arm, with a rectangular cross section, with single showerhead

Standard Configuration

Single showerhead - Body 60x30 mm; showerhead on the side 60 mm

Faucet: “Genius” electronic faucet [cod. 51.200]

Showerhead: Showerhead recessed into the body

Mounting: Visible technical screws

Measurements: Main body 60x30 mm, h 230 mm

Showerhead height 220 mm

Base 200x200 mm, h 40 mm

Materials: AISI 316L stainless steel, quick connection coupling system

Finish: Glossy, mirror-like manual polishing, “nautical” level quality

Hook-up: Water input 1/2”

Extra: Photocells columns

Alternative Faucets

- Mixer (on external column h 80 cm 60x60 mm) [cod. 51.011]
- “Stella” faucet (on external column h 80 cm 60x60 mm) [cod. 51.012]
- Floor-mounted timed flow faucet [cod. 51.004]
- Timed flow faucet (on external column h80 cm 60x60 mm) [cod. 51.013]

Options

- Satin finish [cod. 55.001]
- Telephone showerhead [cod. 53.001]
- Water service output 1/2” [cod. 56.001]

INOX STYLE

MOTIVO



INOX STYLE

MOTIVO DUPLÉ 2B

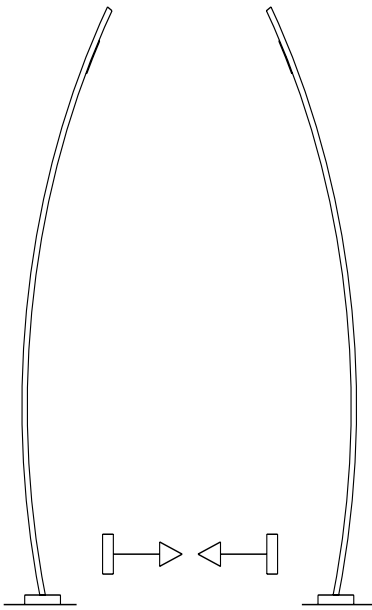

Cod: 01.053

Name: Motivo Duplé (2B) Shower

Description: Shower with two arched arms, opposite to each other with a rectangular cross section, each with single recessed showerhead

Standard Configuration

Arms of 60x30mm with a single showerhead for each arm on the side 60 mm

Faucet: “Genius” electronic faucet [cod. 51.200]

Showerhead: Showerhead recessed into the shower body

Mounting: Visible technical screws

Measurements: Main body 60x30 mm, h 230 cm

Showerhead height 220 cm

Base 200x200 mm, h 40 mm

Materials: AISI 316L stainless steel, quick connection coupling system

Finish: Glossy, mirror-like manual polishing, “nautical” level quality

Hook-up: Water input 1/2”

Extra: Photocells columns

Alternative Faucets

- Mixer on external column h80 cm 60x60 mm [cod. 51.011]
- “Stella” faucet on external column h80 cm 60x60 mm [cod. 51.012]
- Floor-mounted timed flow faucet [cod. 51.004]
- Timed flow faucet on external column h80 cm 60x60 mm [cod. 51.013]

Options

- Satin finish [cod. 55.001]
- Telephone showerhead [cod. 53.001]
- Water service output 1/2” [cod. 56.001]

MOTIVO DUPLÉ 2B



ARIA

Outdoor shower. Single body, circular cross section with arched single arm. Also available with a two arched arm, on opposite sides. Also available in the version **Beach&Garden** with in-ground mounting, suitable for beaches and gardens.

AESTHETIC and FUNCTIONAL CHARACTERISTICS

Shower completely made of AISI 316L stainless steel, in both body and screws.

Mirror-like polishing (“Nautical” quality, manually done): less vulnerable to the elements.

Very few visible screws: reduction of components prone to oxidation.

Invisible mounting screws: plate cover hides screws on the mounting base; better accident prevention and no limestone or rust deposits.

Showerhead with silicone rubber: anti-limestone and anti-obstruction.

Optional auxiliary water output with ½” metal nozzle.

UNIQUE ELEMENTS

Electronic faucet *with timer and hydro-massage functions. Aesthetically pleasant and anti-tampering.*

Faucet assembly produced exclusively for the shower.

Faucet fully integrated into the shower body. *Smaller size and no limestone or rust deposits.*

Possibility of quick connection base *to more easily remove the shower. Easy storage in the winter months and tamper-proof security.*

Customization *(text or logos, lights) is possible upon request.*





INOX TYLE
ARIA

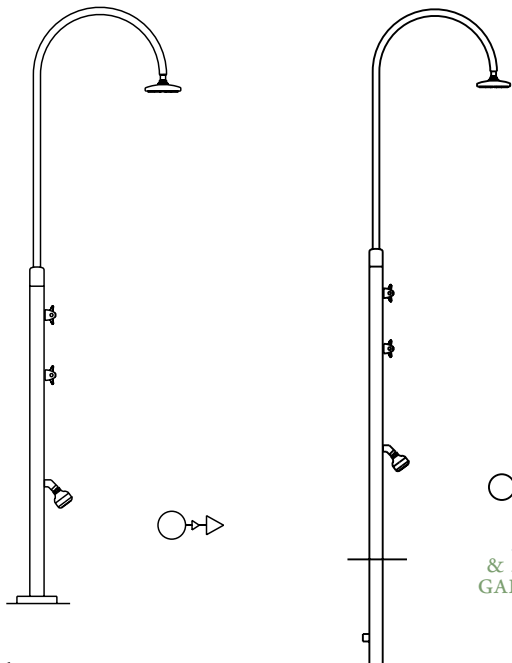

Alternative Faucets

- “Genius” electronic faucet [cod. 51.200]
- Mixer [cod. 51.001]
- Timed flow faucet [cod. 51.003]

Alternative Showerheads

- “Beauty” showerhead dia. 225 mm [cod. 52.001]
- “Disco” showerhead dia. 200 mm [cod. 52.002]
- “Evo” showerhead 200 x 200 mm [cod. 52.101]
- “Evo” showerhead dia. 200 mm [cod. 52.003]
- “Flavia” showerhead 75 x 75 mm [cod. 52.102]
- “Loft” showerhead dia. 65 mm [cod. 52.004]
- “Loft” showerhead dia. 70 mm [cod. 52.005]
- “Stylo” showerhead 200 x 200 mm [cod. 52.103]
- “Zoe” showerhead 150 x 150 mm [cod. 52.104]

Options

- Satin finish [cod. 55.001]
- Mounting backplate [cod. 50.101]
- Foot rinse (faucet Stella & “Loft” or “Flavia” showerhead) [cod. 54.001]
- Telephone showerhead [cod. 53.001]
- Water service output 1/2” [cod. 56.001]
- Quick connection base (extractable shower) [cod. 50.200]

Cod: 01.004
Name: Aria Shower
Description: Single body shower, with circular cross section and single arched arm

Standard Configuration

Single body
Faucet: “Stella” faucet [cod. 51.002]
Showerhead: “Ocean” showerhead dia. 150 mm [cod. 52.006]
Mounting: Bottom plate dia. 170 mm [cod. 50.004]
Measurements: Body dia.60 mm, h 140 cm
 Arc dia. 30 mm
 Showerhead h 210 cm
Materials: AISI 316L stainless steel, quick connection fitting
Finish: Glossy, mirror-like manual polishing, “nautical” level quality
Hook-up: Water input 1/2”

In-ground Mounting Configuration

Cod: 02.005
Description: In-ground mounting variant
Mounting: In-ground mounting [cod. 50.100]
Measurements: Body dia.60 mm, h 230 cm
 (90 cm in-ground) - Arc dia. 30 mm - Showerhead h 210 cm

INOX TYLE
ARIA

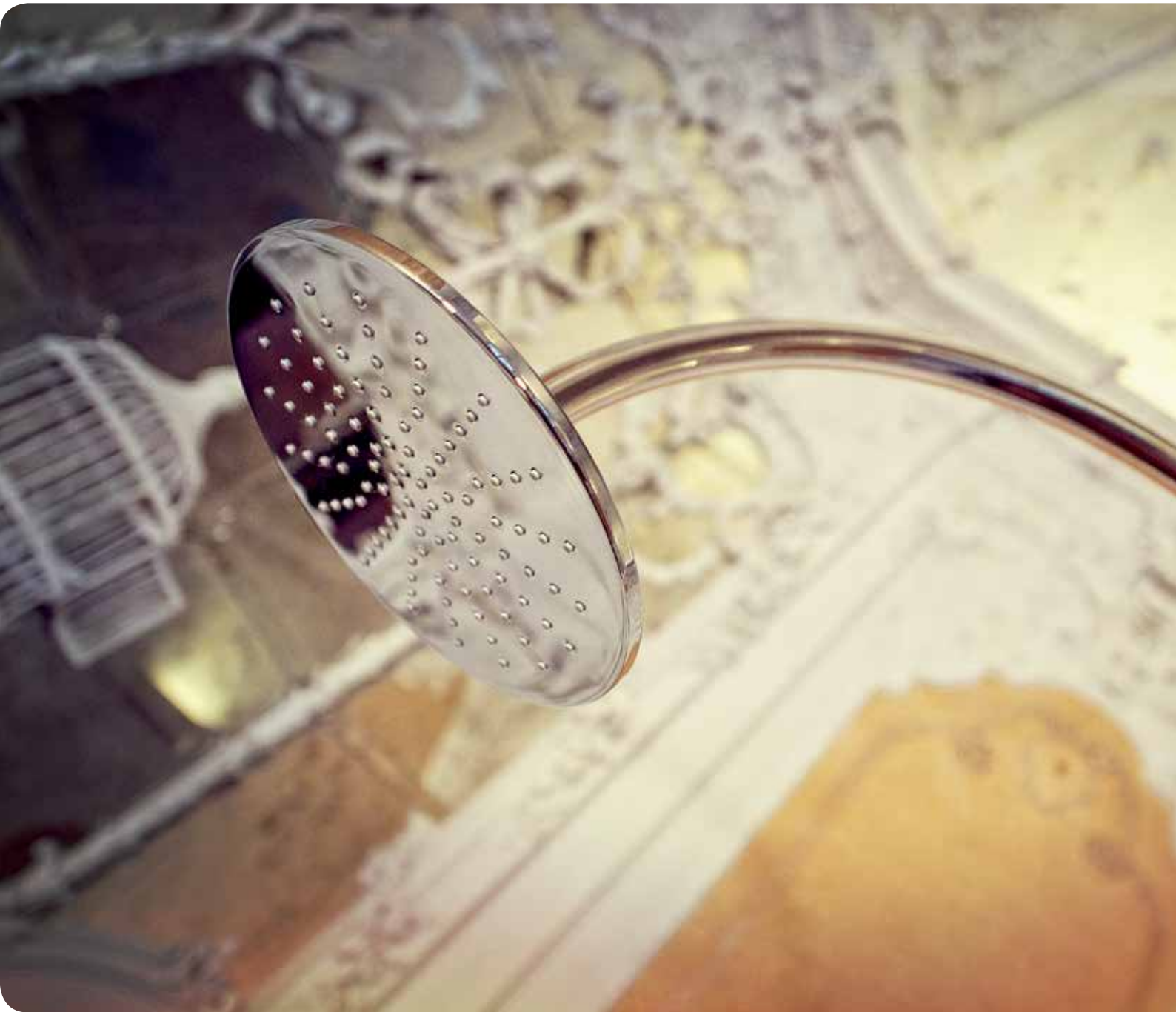

ARIA 2B

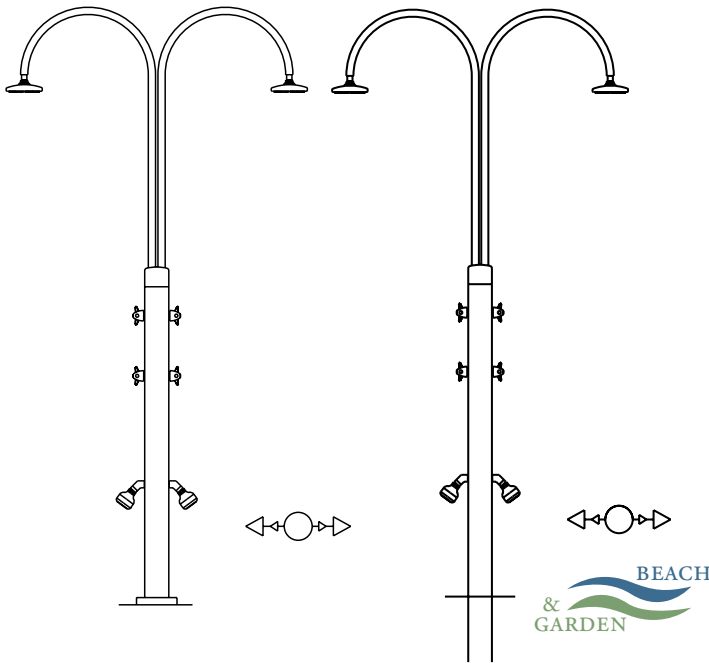

Alternative Faucets

- “Genius” electronic faucet [cod. 51.200]
- Mixer [cod. 51.001]
- Timed flow faucet [cod. 51.003]

Alternative Showerheads

- “Beauty” showerhead dia. 225 mm [cod. 52.001]
- “Disco” showerhead dia. 200 mm [cod. 52.002]
- “Evo” showerhead 200 x 200 mm [cod. 52.101]
- “Evo” showerhead dia. 200 mm [cod. 52.003]
- “Flavia” showerhead 75 x 75 mm [cod. 52.102]
- “Loft” showerhead dia. 65 mm [cod. 52.004]
- “Loft” showerhead dia. 70 mm [cod. 52.005]
- “Stylo” showerhead 200 x 200 mm [cod. 52.103]
- “Zoe” showerhead 150 x 150 mm [cod. 52.104]

Options

- Satin finish [cod. 55.001]
- Mounting backplate [cod. 50.101]
- Foot rinse (faucet Stella & “Loft” or “Flavia” showerhead) [cod. 54.001]
- Telephone showerhead [cod. 53.001]
- Water service output 1/2” [cod. 56.001]

Cod: 01.051

Name: Aria 2B Shower

Description: Single body shower, with circular cross section and two arched arms, opposite to each other

Standard Configuration

Single shower body with two arms

Faucet: “Stella” faucet [cod. 51.002]

Showerhead: “Ocean” showerhead dia. 150 mm [cod. 52.006]

Mounting: Bottom plate dia. 170 mm [cod. 50.004]

Measurements: Main body dia. 100 mm, h 140 cm

Arched end dia. 30 mm

Showerhead height 210 cm

Materials: AISI 316L stainless steel, quick connection coupling system

Finish: Glossy, mirror-like manual polishing, “nautical” level quality

Hook-up: Water input 1/2”

In-ground Mounting Configuration

Cod: 02.142

Description: In-ground mounting variant

Mounting: In-ground mounting [cod. 50.100]

Measurements: Main body dia. 100 mm, h 230 cm

(90 cm in-ground) - arched end

dia. 30 mm - Height Showerhead 210 cm

ARIA 2B



PRELUDIO

Shower with two arched and intertwined arms, with a rectangular cross section, each with single recessed showerhead. Also available in a version with two arched arms, opposite to each other, with a rectangular cross section or with a single curved arm, with a rectangular cross section.

AESTHETIC and FUNCTIONAL CHARACTERISTICS

Shower completely made of AISI 316L stainless steel, in both body and screws.

Mirror-like polishing (“Nautical” quality, manually done): less vulnerable to the elements.

Product made in a single piece: no block assembly or junctions.

Very few visible screws: reduction of components that are prone to oxidization and wonderful aesthetics.

Showerhead with silicone rubber: anti-limestone and anti-obstruction.

Optional auxiliary water output with ½” metal nozzle.

UNIQUE ELEMENTS

Showerhead recessed in each shower arm.

Electronic faucet *with timer and hydro-massage functions. Aesthetically pleasant and anti-tampering.*

Customization *(text or logos, lights) is possible upon request.*





PRELUDIO 2B

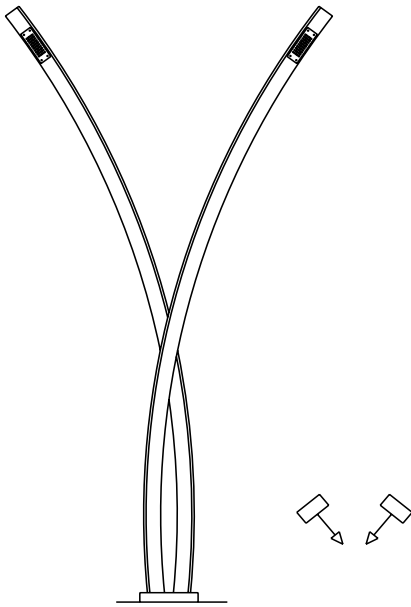

Cod: 01.034

Name: Preludio (2B) Shower

Description: Shower with two arched and intertwined arms, with a rectangular cross section, each with single recessed showerhead.

Standard Configuration

60x30 mm arms with a single showerhead recessed for each arm on the side 60 mm

Faucet: "Genius" electronic faucet [cod. 51.200]

Showerhead: Showerhead recessed into the shower body

Mounting: Visible mounting

Measurements: Main body 60x30 mm, h 230 cm

Showerhead height 220 cm

Base 240x240 mm, h 40 mm

Materials: AISI 316L stainless steel, quick connection coupling system

Finish: Glossy, mirror-like manual polishing, "nautical" level quality

Hook-up: Water input 1/2"

Extra: Photocells columns

Alternative Faucets

- Mixer on external column [cod. 51.011]
h 80 cm 60x60 mm
- "Stella" faucet on external column [cod. 51.012]
h 80 cm 60x60 mm
- Floor-mounted timed flow faucet [cod. 51.004]
- Timed flow faucet su Column esterna [cod. 51.013]
h 80 cm 60x60 mm

Options

- Satin finish [cod. 55.001]
- Telephone showerhead [cod. 53.001]
- Water service output 1/2" [cod. 56.001]

PRELUDIO 2B



MELODY

Shower in a single body, with a circular cross section, with three arched arms arranged at 120°. Also available in a version with two arched arms, opposite to each other, or with four perpendicular arched arms.

Also available in the version Beach&Garden with in-ground mounting, suitable for beaches and gardens.

AESTHETIC and FUNCTIONAL CHARACTERISTICS

Shower completely made of AISI 316L stainless steel, in both body and screws.

Mirror-like polishing (“Nautical” quality, manually done): less vulnerable to the elements.

Very few visible screws: reduction of components prone to oxidation.

Invisible mounting plate cover hides screws on the mounting base: better accident prevention and no limestone or rust deposits.

Showerhead with silicone rubber: anti-limestone and anti-obstruction.

Optional auxiliary water output with ½” metal nozzle.

UNIQUE ELEMENTS

Electronic faucet with timer and hydro-massage functions. Aesthetically pleasant and anti-tampering.

Faucet assembly produced exclusively for the shower.

Faucet fully integrated into the shower body. Smaller size and no limestone or rust deposits.

Possibility of quick connection base to remove the shower more easily. Easy storage in the winter months and tamper-proof security.

Customization (text or logos, lights) is possible upon request.





MELODY 2B

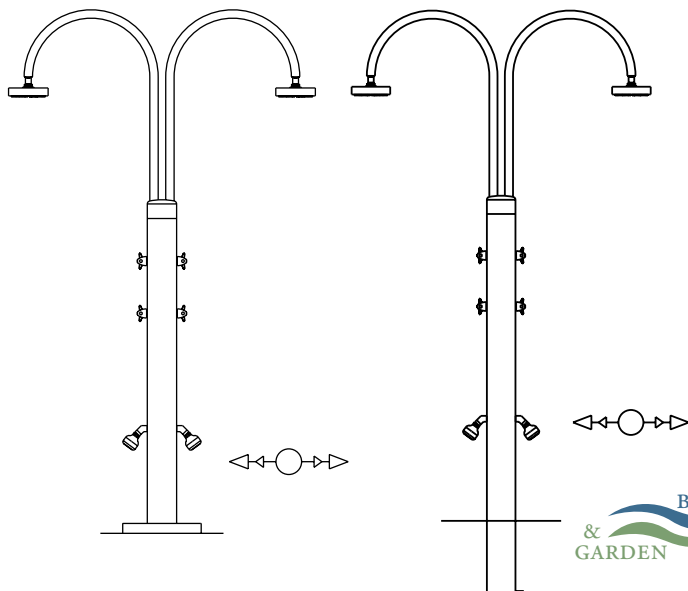

Cod: 01.048

Name: Melody 2B Shower

Description: Shower in a unique body, with a circular cross section and two arched arms, opposite to each other

Standard Configuration

Single shower body with two arms

Faucet: “Stella” faucet [cod. 51.002]

Showerhead: “Disco” showerhead dia. 200 mm [cod. 52.002]

Mounting: Bottom plate dia. 280 mm [cod. 50.005]

Measurements: Main body dia. 140 mm, h 160 cm

Arched end dia. 40 mm

Showerhead height 210 cm

Materials: AISI 316L stainless steel, quick connection coupling system

Finish: Glossy, mirror-like manual polishing, “nautical” level quality

Hook-up: Water input 3/4”



In-ground Mounting Configuration

Cod: 02.047

Description: In-ground mounting variant

Mounting: In-ground mounting [cod. 50.100]

Measurements: Main body dia. 140 mm, 250 cm

(90 cm in-ground)

Arched end dia. 40 mm

Showerhead height 210 cm

Alternative Faucets

- “Genius” electronic faucet [cod. 51.200]
- Mixer [cod. 51.001]
- Timed flow faucet [cod. 51.003]

Alternative Showerheads

- “Beauty” showerhead dia. 225 mm [cod. 52.001]
- “Evo” showerhead 200 x 200 mm [cod. 52.101]
- “Evo” showerhead dia. 200 mm [cod. 52.003]
- “Flavia” showerhead 75 x 75 mm [cod. 52.102]
- “Loft” showerhead dia. 65 mm [cod. 52.004]
- “Loft” showerhead dia. 70 mm [cod. 52.005]
- “Ocean” showerhead dia. 150 mm [cod. 52.006]
- “Stylo” showerhead 200 x 200 mm [cod. 52.103]
- “Zoe” showerhead 150 x 150 mm [cod. 52.104]

Options

- Satin finish [cod. 55.001]
- Mounting backplate [cod. 50.101]
- Foot rinse (faucet Stella & “Loft” or “Flavia” showerhead) [cod. 54.001]
- Telephone showerhead [cod. 53.001]
- Water service output 1/2” [cod. 56.001]

MELODY 2B



MELODY 3B

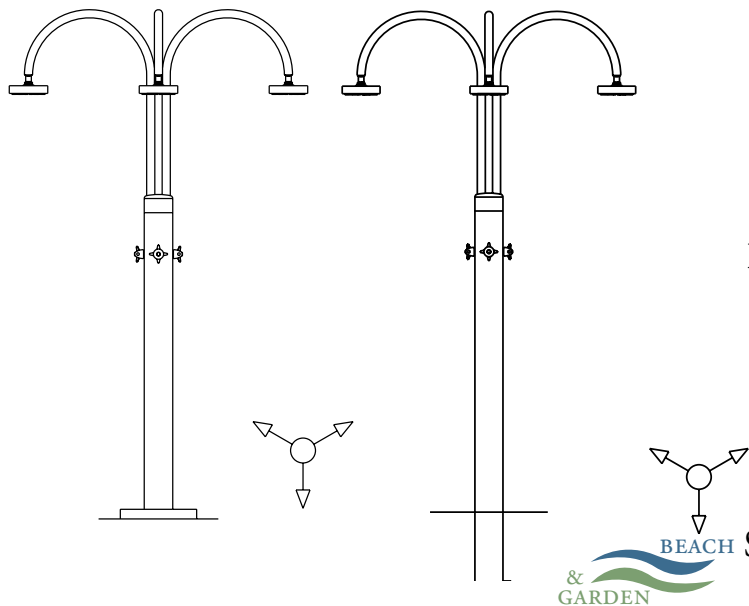

Cod: 01.027

Name: Melody 3B Shower

Description: Shower in a unique body, with a circular cross section and three arched arms arranged at 120°

Standard Configuration

Single shower body with three arms

Faucet: “Stella” faucet [cod. 51.002]

Showerhead: “Disco” showerhead dia. 200 mm [cod. 52.002]

Mounting: Bottom plate dia. 280 mm [cod. 50.005]

Measurements: Main body dia. 140 mm, h 160 cm

Arched end dia. 40 mm

Showerhead height 210 cm

Materials: AISI 316L stainless steel, quick connection coupling system

Finish: Glossy, mirror-like manual polishing, “nautical” level quality

Hook-up: Water input 3/4”

In-ground Mounting Configuration



Cod: 02.049

Description: In-ground mounting variant

Mounting: In-ground mounting [cod. 50.100]

Measurements: Main body dia. 140 mm, 250 cm (90 cm in-ground)

Arched end dia. 40 mm

Showerhead height 210 cm

Alternative Faucets

- “Genius” electronic faucet [cod. 51.200]
- Mixer [cod. 51.001]
- Timed flow faucet [cod. 51.003]

Alternative Showerheads

- “Beauty” showerhead dia. 225 mm [cod. 52.001]
- “Evo” showerhead 200 x 200 mm [cod. 52.101]
- “Evo” showerhead dia. 200 mm [cod. 52.003]
- “Flavia” showerhead 75 x 75 mm [cod. 52.102]
- “Loft” showerhead dia. 65 mm [cod. 52.004]
- “Loft” showerhead dia. 70 mm [cod. 52.005]
- “Ocean” showerhead dia. 150 mm [cod. 52.006]
- “Stylo” showerhead 200 x 200 mm [cod. 52.103]
- “Zoe” showerhead 150 x 150 mm [cod. 52.104]

Options

- Satin finish [cod. 55.001]
- Mounting backplate [cod. 50.101]
- Foot rinse (faucet Stella & “Loft” or “Flavia” showerhead) [cod. 54.001]
- Telephone showerhead [cod. 53.001]
- Water service output 1/2” [cod. 56.001]

MELODY 3B

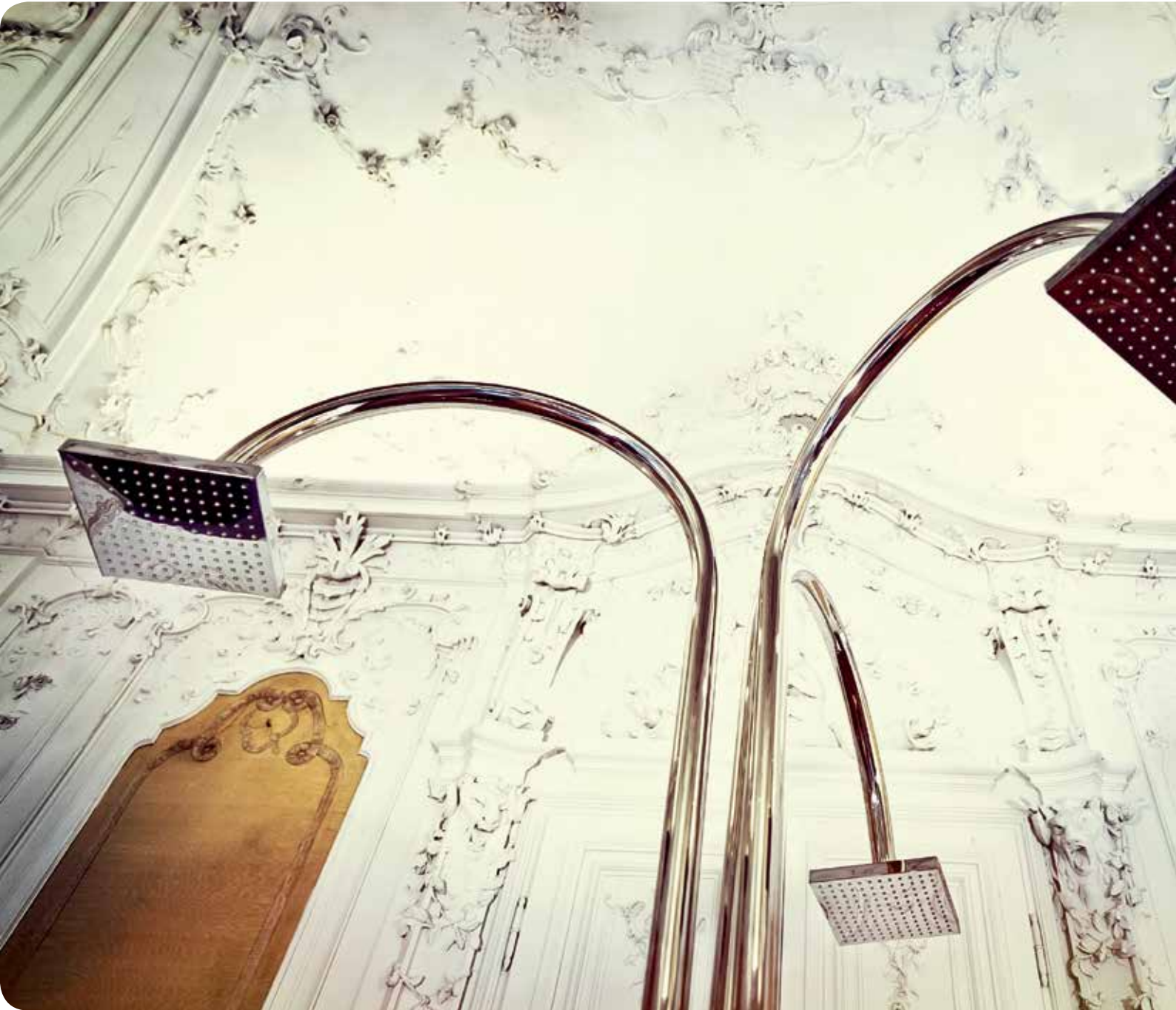

MELODY 4B

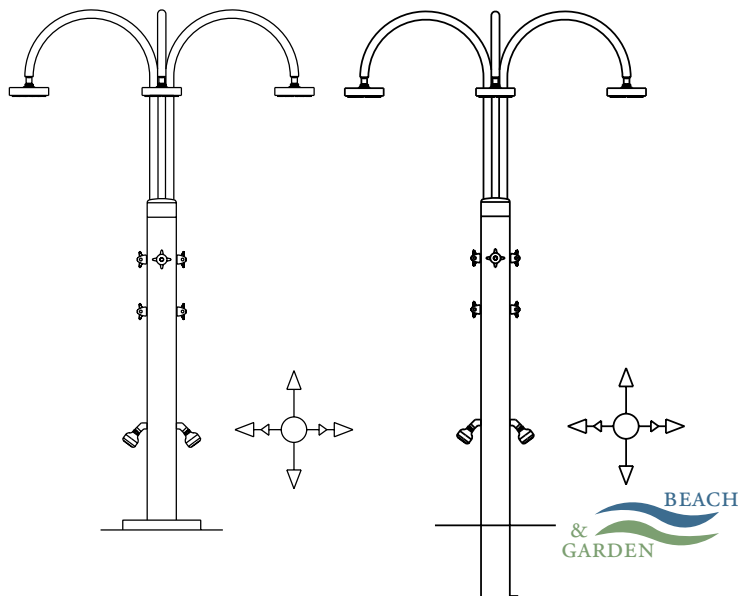

Cod: 01.050

Name: Melody 4B Shower

Description: Shower in a unique body, with a circular cross section and four perpendicular arched arms

Standard Configuration

Single shower body with four arms

Faucet: “Stella” faucet [cod. 51.002]

Showerhead: “Disco” showerhead dia. 200 mm [cod. 52.002]

Mounting: Bottom plate dia. 280 mm [cod. 50.005]

Measurements: Main body dia. 140 mm, h 160 cm

Arched end dia. 40 mm

Showerhead height 210 cm

Materials: AISI 316L stainless steel, quick connection coupling system

Finish: Glossy, mirror-like manual polishing, “nautical” level quality

Hook-up: Water input 3/4”

In-ground Mounting Configuration



Cod: 02.146

Description: In-ground mounting variant

Mounting: In-ground mounting [cod. 50.100]

Measurements: Main body dia. 140 mm, 250 cm

(90 cm in-ground)

Arched end dia. 40 mm

Showerhead height 210 cm

Alternative Faucets

- “Genius” electronic faucet [cod. 51.200]
- Mixer [cod. 51.001]
- Timed flow faucet [cod. 51.003]

Alternative Showerheads

- “Beauty” showerhead dia. 225 mm [cod. 52.001]
- “Evo” showerhead 200 x 200 mm [cod. 52.101]
- “Evo” showerhead dia. 200 mm [cod. 52.003]
- “Flavia” showerhead 75 x 75 mm [cod. 52.102]
- “Loft” showerhead dia. 65 mm [cod. 52.004]
- “Loft” showerhead dia. 70 mm [cod. 52.005]
- “Ocean” showerhead dia. 150 mm [cod. 52.006]
- “Stylo” showerhead 200 x 200 mm [cod. 52.103]
- “Zoe” showerhead 150 x 150 mm [cod. 52.104]

Options

- Satin finish [cod. 55.001]
- Mounting backplate [cod. 50.101]
- Foot rinse [cod. 54.001]
- (faucet Stella & “Loft” or “Flavia” showerhead)
- Telephone showerhead [cod. 53.001]
- Water service output 1/2” [cod. 56.001]

MELODY 4B

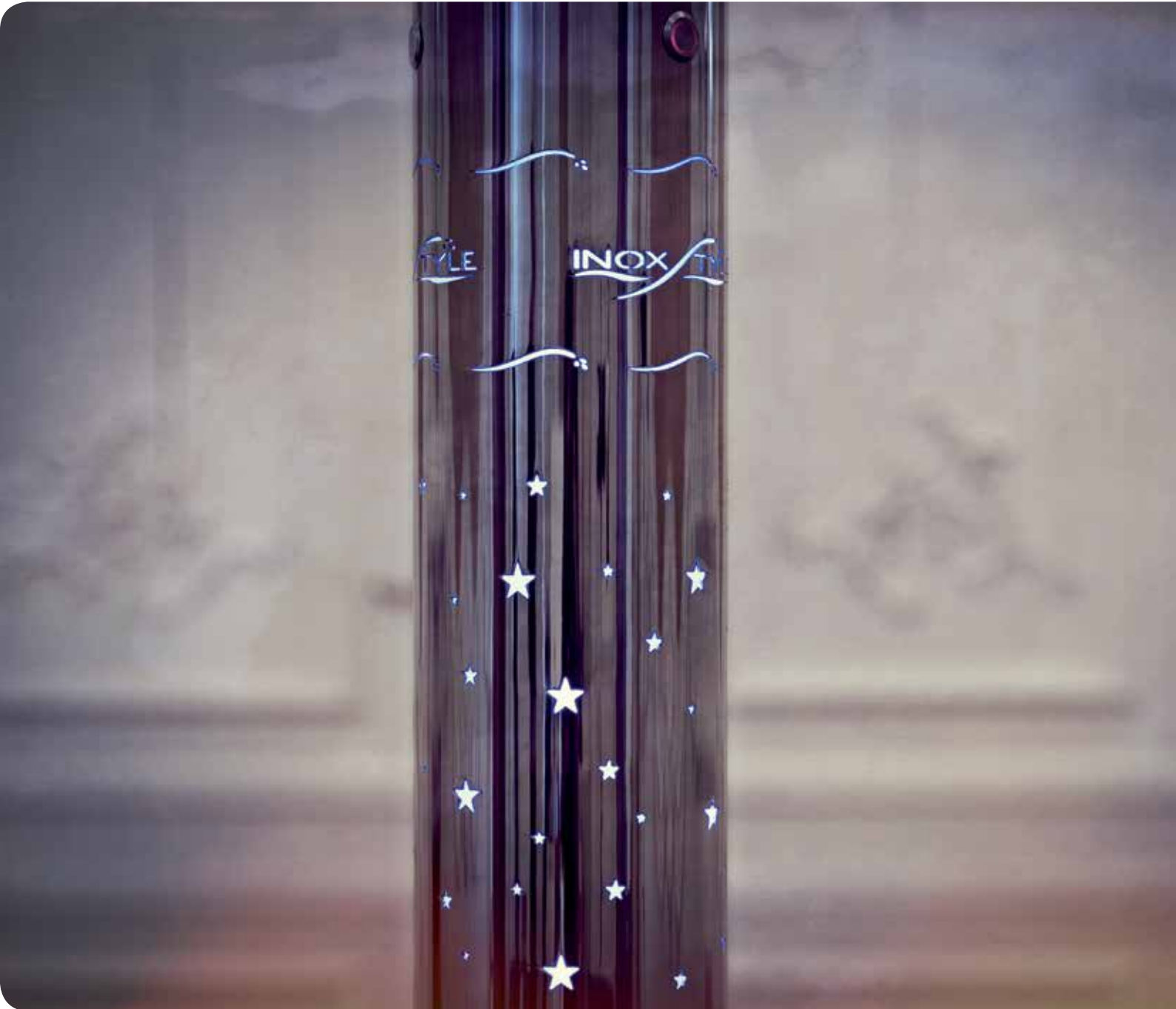

ARMONIA

Wave-shaped waterfall for swimming pool ledge, with a rectangular cross section.

AESTHETIC CHARACTERISTICS and FUNCTIONAL

Waterfall completely in stainless steel AISI 316L, in both body and screws.

Mirror-like polishing (“Nautical” quality, manually done): less vulnerable to the elements.

UNIQUE ELEMENTS

Customization, upon request, of the profile shape of the waterfall.





WATERFALL ARMONIA

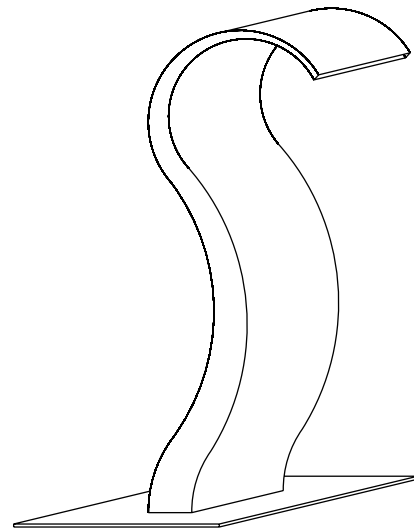

Cod: 07.036

Name: Armonia Waterfall

Description: Wave-shaped waterfall for swimming pool ledge, with a rectangular cross section

Standard Configuration

Mounting: Visible mounting

Measurements: Main body 200x100 mm

Height tot. 65 cm - Aperture 200 mm

Base 300x200 mm

Materials: AISI 316L stainless steel

Finish: Glossy, mirror-like manual polishing, "nautical" level quality

Hook-up: Water input 2"

Options

• Satin finish

[cod. 55.001]

WATERFALL ARMONIA



YACHT
RIVA
AURORA

MARE NOSTRUM



YACHT

Outdoor shower. Single arched body, with oval cross section and integrated, fixed showerhead.
Also available in the version Beach&Garden with in-ground mounting, suitable for beaches and gardens.

AESTHETIC and FUNCTIONAL CHARACTERISTICS

Shower completely made of AISI 316L stainless steel, in both body and screws.

Mirror-like polishing (“Nautical” quality, manually done): less vulnerable to the elements.

Product made in a single piece: no block assembly or junctions.

Very few visible screws: reduction of components that are prone to oxidization and wonderful aesthetics.

Showerhead with silicone rubber: anti-limestone and anti-obstruction.

Optional auxiliary water output with ½” metal nozzle.

UNIQUE ELEMENTS

Electronic faucet with timer and hydro-massage functions.
Aesthetically pleasant and anti-tampering.

Faucet assembly produced exclusively for the shower.

Faucet fully integrated into the shower body. Smaller size and no limestone or rust deposits.

Possibility of quick connection base to more easily remove the shower. Easy storage in the winter months and tamper-proof security.

Customization (text or logos, lights) is possible upon request.





YACHT

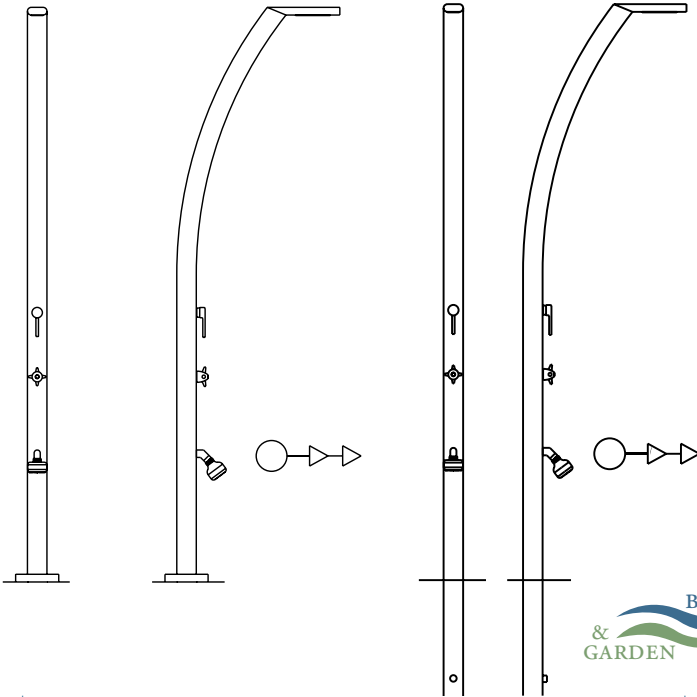

Cod: 01.019

Name: Yacht Shower

Description: Single arched body, with oval cross section and integrated, fixed showerhead.

Standard Configuration

Single shower

Faucet: Mixer [cod. 51.001]

Showerhead: Showerhead integrated

Mounting: Bottom plate dia. 170 mm [cod. 50.004]

Measurements: Body dia. 76 mm
oval 76x35 mm, h 220 cm

Materials: AISI 316L stainless steel, quick coupling fitting system

Finish: Glossy, mirror-like manual polishing, "nautical" level quality

Hook-up: Water input 1/2"



Alternative Faucets

- "Genius" electronic faucet [cod. 51.200]

Alternative Showerheads

- "Beauty" showerhead dia. 225 mm [cod. 52.001]
- "Disco" showerhead dia. 200 mm [cod. 52.002]
- "Evo" showerhead 200 x 200 mm [cod. 52.101]
- "Evo" showerhead dia. 200 mm [cod. 52.003]
- "Flavia" showerhead 75 x 75 mm [cod. 52.102]
- "Loft" showerhead dia. 65 mm [cod. 52.004]
- "Loft" showerhead dia. 70 mm [cod. 52.005]
- "Ocean" showerhead dia. 150 mm [cod. 52.006]
- "Stylo" showerhead 200 x 200 mm [cod. 52.103]
- "Zoe" showerhead 150 x 150 mm [cod. 52.104]

Options

- Satin finish [cod. 55.001]
- Mounting backplate [cod. 50.101]
- Quick connection base [cod. 50.200]
- Foot rinse (Faucet faucet & "Loft" or "Flavia" showerhead) [cod. 54.001]
- Telephone showerhead [cod. 53.001]
- Water service output 1/2" [cod. 56.001]

In-ground Mounting Configuration

Cod: 02.143

Description: In-ground mounting variant

Mounting: In-ground mounting [cod. 50.100]

Measurements: Body dia. 76 mm, oval 76x35 mm,
h 310 cm (90 cm in-ground)



YACHT



RIVA

O utdoor shower. Single body circular cross-section with elbow fitted arm. Also available in the “Beach and Garden” model with in-ground installation suitable for beaches and gardens.

Also available in the “Florida” model with elbow fitted arm and steel and wooden raised platform for above ground installation.

AESTHETIC & FUNCTIONAL CHARACTERISTICS

Shower completely made of AISI 316L stainless steel, in both body and screws.

Mirror-like polishing (“Nautical” quality, manually done): less vulnerable to the elements.

No visible screws: reduction of components that are prone to oxidization and wonderful aesthetics.

Showerhead with silicone rubber: anti-limestone and anti-obstruction.

Optional **water service output** with ½” metal nozzle.

UNIQUE ELEMENTS

Electronic faucet *with timer and hydro-massage functions. Aesthetically pleasant and anti-tampering.*

Faucet body *made exclusively for the shower.*

Faucet fully integrated *into the shower body. Smaller size and no limestone or rust deposits.*

Possibility of quick connection base *to more easily remove the shower. Easy storage in the winter months and tamper-proof security.*

Customization *(text or logos, lights) is possible upon request.*





RIVA

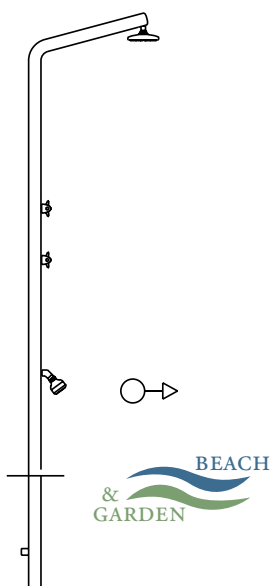
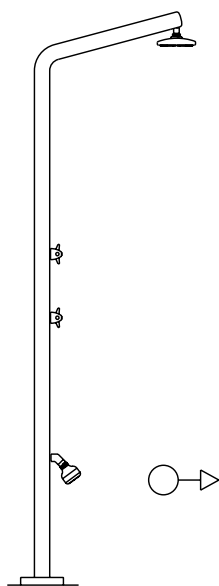

Alternative Faucets

- “Genius” electronic faucet [cod. 51.200]
- Mixer [cod. 51.001]
- Timed flow faucet [cod. 51.003]

Alternative Showerheads

- “Beauty” showerhead dia. 225 mm [cod. 52.001]
- “Disco” showerhead dia. 200 mm [cod. 52.002]
- “Evo” showerhead 200 x 200 mm [cod. 52.101]
- “Evo” showerhead dia. 200 mm [cod. 52.003]
- “Flavia” showerhead 75 x 75 mm [cod. 52.102]
- “Loft” showerhead dia. 65 mm [cod. 52.004]
- “Ocean” showerhead dia. 150 mm [cod. 52.006]
- “Stylo” showerhead 200 x 200 mm [cod. 52.103]
- “Zoe” showerhead 150 x 150 mm [cod. 52.104]

Options

- Satin finish [cod. 55.001]
- Mounting backplate [cod. 50.101]
- Quick connection base [cod. 50.200]
- Foot rinse (“Stella” faucet, “Loft” or “Flavia” showerhead) [cod. 54.001]
- Telephone showerhead [cod. 53.001]
- Water service output 1/2” [cod. 56.001]

Cod: 01.006

Name: Riva shower

Description: Single body, with circular cross section and arm with arched connector

Standard Configuration

Single shower

Faucet: “Stella” faucet [cod. 51.002]

Showerhead: “Loft” showerhead dia. 70 mm [cod. 52.005]

Mounting: Bottom plate dia. 170 mm [cod. 50.004]

Measurements: Body dia. 60 mm

Height 230 cm

Materials: AISI 316L stainless steel, quick connection water coupling

Finish: Glossy, mirror-like manual polishing, “Nautical” level quality

Hook-up: Water input 1/2”



In- ground installation Configuration

Cod: 02.007

Description: Variant for in-ground installation

Mounting: In-ground Mounting [cod. 50.100]

Measurements: Body dia. 60 mm

Height h 320 cm (90 cm in-ground)

INOX TYLE

RIVA



INOX TYLE

FLORIDA

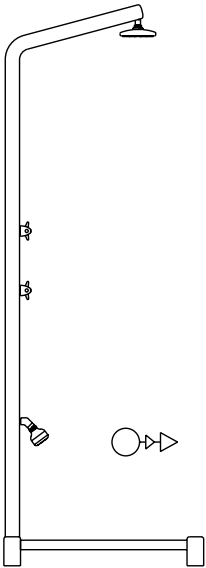

Cod: 01.003
Name: Florida Shower
Description: Shower in a unique body of circular cross-section with arm with curved connection with platform in steel and wood raised for mounting out of the ground

Alternative Faucets

- “Genius” electronic faucet [cod. 51.200]
- Mixer [cod. 51.001]
- Timed flow faucet [cod. 51.003]

Alternative Showerheads

- “Beauty” showerhead dia. 225 mm [cod. 52.001]
- “Disco” showerhead dia. 200 mm [cod. 52.002]
- “Evo” showerhead 200 x 200 mm [cod. 52.101]
- “Evo” showerhead dia. 200 mm [cod. 52.003]
- “Flavia” showerhead 75 x 75 mm [cod. 52.102]
- “Loft” showerhead dia. 65 mm [cod. 52.004]
- “Loft” showerhead dia. 70 mm [cod. 52.005]
- “Stylo” showerhead 200 x 200 mm [cod. 52.103]
- “Zoe” showerhead 150 x 150 mm [cod. 52.104]

Options

- Satin finish [cod. 55.001]
- Foot rinse (faucet Stella & “Loft” or “Flavia” showerhead) [cod. 54.001]
- Telephone showerhead [cod. 53.001]
- Water service output 1/2” [cod. 56.001]

Standard Configuration

Single shower with TATAJUBA wood 80x80 120 mm raised footboard with 4 support feet on the ground.

- Faucet:** “Stella” faucet [cod. 51.002]
Showerhead: “Ocean” showerhead dia. 150 mm [cod. 52.006]
Mounting: No mounting
Measurements: Body dia. 60 mm
 Height 240 cm
Materials: AISI 316L stainless steel, quick connection coupling system
Finish: Glossy, mirror-like manual polishing, “nautical” level quality
Hook-up: Water input 1/2”
Extra: Mounting option on sand, with appropriate setup

FLORIDA



AURORA

Single body, T-shaped shower, with a circular cross section, with four perpendicular arms. Also available in a version with two arms, opposite to each other, or with three arms, arranged at 120°.

Also available in the version Beach&Garden with in-ground mounting, suitable for beaches and gardens.

AESTHETIC and FUNCTIONAL CHARACTERISTICS

Shower completely made of AISI 316L stainless steel, in both body and screws.

Mirror-like polishing (“Nautical” quality, manually done): less vulnerable to the elements.

Very few visible screws: reduction of components prone to oxidation.

Invisible mounting plate cover hides screws on the mounting base: better accident prevention and no limestone or rust deposits.

Showerhead with silicone rubber: anti-limestone and anti-obstruction.

Optional auxiliary water output with ½” metal nozzle.

UNIQUE ELEMENTS

Electronic faucet with timer and hydro-massage functions. Aesthetically pleasant and anti-tampering.

Faucet assembly produced exclusively for the shower.

Faucet fully integrated into the shower body. Smaller size and no limestone or rust deposits.

Possibility of quick connection base to more easily remove the shower. Easy storage in the winter months and tamper-proof security.

Customization (text or logos, lights) is possible upon request.





AURORA 2B

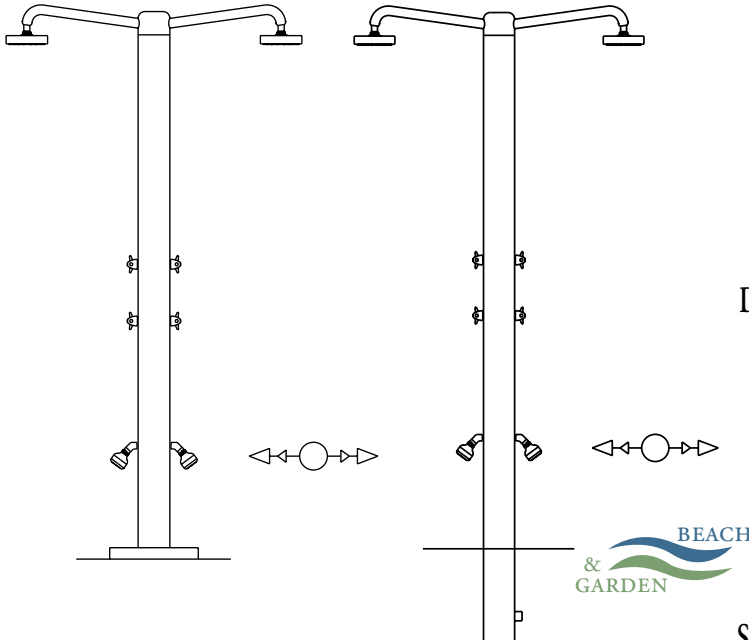

Cod: 01.001

Name: Aurora 2B Shower

Description: Single body, T-shaped shower, with a circular cross section with two arched arms, opposite to each other

Standard Configuration

Single shower body with two arms

Faucet: “Stella” faucet [cod. 51.002]

Showerhead: “Disco” showerhead dia. 200 mm [cod. 52.002]

Mounting: Bottom plate dia. 280 mm [cod. 50.005]

Measurements: Main body dia. 140 mm, h 220 cm
Shower arms dia. 40 mm
Showerhead height 210 cm

Materials: AISI 316L stainless steel, quick connection coupling system

Finish: Glossy, mirror-like manual polishing, “nautical” level quality

Hook-up: Water input 3/4”



In-ground Mounting Configuration

Cod: 02.004

Description: In-ground mounting variant

Mounting: In-ground mounting [cod. 50.100]

Measurements: Main body dia. 140 mm, h 330 cm (90 cm in-ground). Shower arms dia. 40 mm
Showerhead height 210 cm

Alternative Faucets

- “Genius” electronic faucet [cod. 51.200]
- Mixer [cod. 51.001]
- Timed flow faucet [cod. 51.003]

Alternative Showerheads

- “Beauty” showerhead dia. 225 mm [cod. 52.001]
- “Evo” showerhead 200 x 200 mm [cod. 52.101]
- “Evo” showerhead dia. 200 mm [cod. 52.003]
- “Flavia” showerhead 75 x 75 mm [cod. 52.102]
- “Loft” showerhead dia. 65 mm [cod. 52.004]
- “Loft” showerhead dia. 70 mm [cod. 52.005]
- “Ocean” showerhead dia. 150 mm [cod. 52.006]
- “Stylo” showerhead 200 x 200 mm [cod. 52.103]
- “Zoe” showerhead 150 x 150 mm [cod. 52.104]

Options

- Satin finish [cod. 55.001]
- Mounting backplate [cod. 50.101]
- Foot rinse (faucet Stella & “Loft” or “Flavia” showerhead) [cod. 54.001]
- Telephone showerhead [cod. 53.001]
- Water service output 1/2” [cod. 56.001]

INOX TYLE

AURORA 2B



INOX TYLE

AURORA 3B

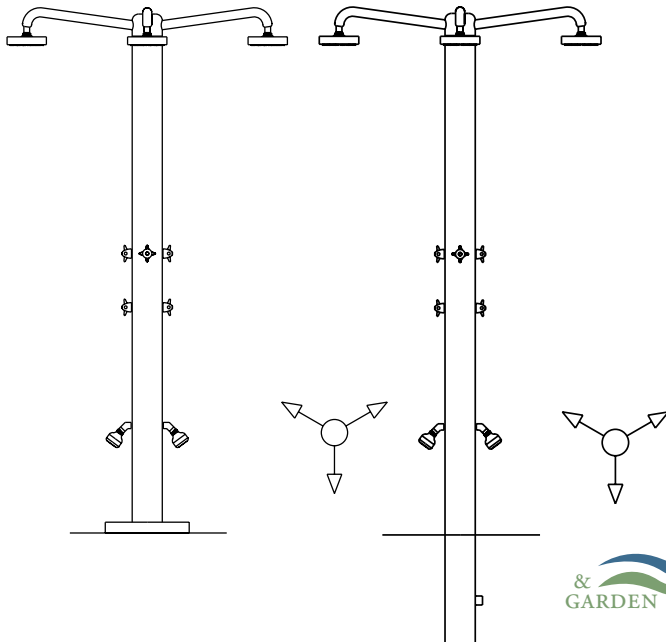

Cod: 01.145

Name: Aurora 3B Shower

Description: Single body, T-shaped shower, with a circular cross section, with three arms at 120°

Standard Configuration

Single shower body with three arms

Faucet: "Stella" faucet [cod. 51.002]

Showerhead: "Disco" showerhead dia. 200 mm [cod. 52.002]

Mounting: Bottom plate dia. 280 mm [cod. 50.005]

Measurements: Main body dia. 140 mm, h 220 cm

Shower arms dia. 40 mm

Showerhead height 210 cm

Materials: AISI 316L stainless steel, quick connection coupling system

Finish: Glossy, mirror-like manual polishing, "nautical" level quality

Hook-up: Water input 3/4"

In-ground Mounting Configuration

Cod: 02.140

Description: In-ground mounting variant

Mounting: In-ground mounting [cod. 50.100]

Measurements: Main body dia. 140 mm, h 330 cm (90 cm in-ground)

Shower arms dia. 40 mm

Showerhead height 210 cm

Alternative Faucets

- "Genius" electronic faucet [cod. 51.200]
- Mixer [cod. 51.001]
- Timed flow faucet [cod. 51.003]

Alternative Showerheads

- "Beauty" showerhead dia. 225 mm [cod. 52.001]
- "Evo" showerhead 200 x 200 mm [cod. 52.101]
- "Evo" showerhead dia. 200 mm [cod. 52.003]
- "Flavia" showerhead 75 x 75 mm [cod. 52.102]
- "Loft" showerhead dia. 65 mm [cod. 52.004]
- "Loft" showerhead dia. 70 mm [cod. 52.005]
- "Ocean" showerhead dia. 150 mm [cod. 52.006]
- "Stylo" showerhead 200 x 200 mm [cod. 52.103]
- "Zoe" showerhead 150 x 150 mm [cod. 52.104]

Options

- Satin finish [cod. 55.001]
- Mounting backplate [cod. 50.101]
- Foot rinse (faucet Stella & "Loft" or "Flavia" showerhead) [cod. 54.001]
- Telephone showerhead [cod. 53.001]
- Water service output 1/2" [cod. 56.001]



INOX TYLE

AURORA 3B



INOX TYLE

AURORA 4B

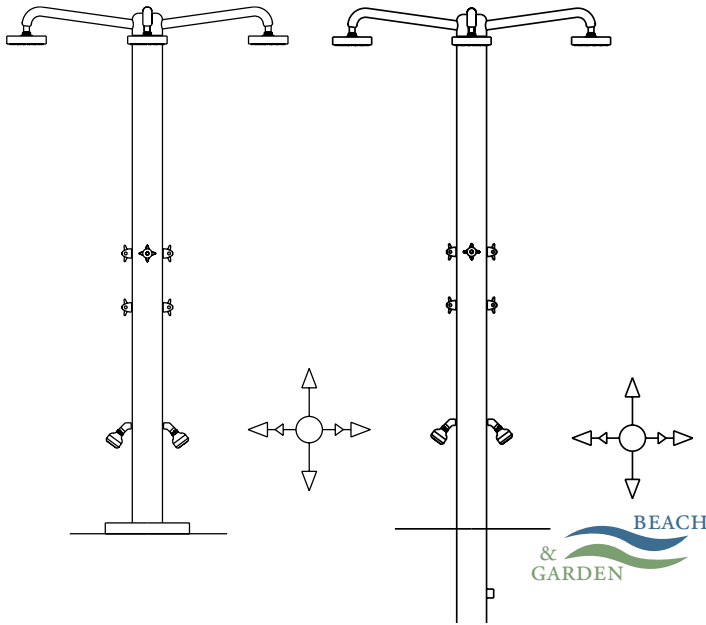

Cod: 01.002

Name: Aurora 4B Shower

Description: Single body, T-shaped shower, with a circular cross section, with four perpendicular arms

Standard Configuration

Single shower body with four arms

Faucet: “Stella” faucet [cod. 51.002]

Showerhead: “Disco” showerhead dia. 200 mm [cod. 52.002]

Mounting: Bottom plate dia. 280 mm [cod. 50.005]

Measurements: Main body dia. 140 mm, h 220 cm

Shower arms dia. 40 mm

Showerhead height 210 cm

Materials: AISI 316L stainless steel, quick connection coupling system

Finish: Glossy, mirror-like manual polishing, “nautical” level quality

Hook-up: Water input 3/4”

In-ground Mounting Configuration



Cod: 02.003

Description: In-ground mounting variant

Mounting: In-ground mounting [cod. 50.100]

Measurements: Main body dia. 140 mm, h 330 cm

(90 cm in-ground)

Shower arms dia. 40 mm

Showerhead height 210 cm

Alternative Faucets

- “Genius” electronic faucet [cod. 51.200]
- Mixer [cod. 51.001]
- Timed flow faucet [cod. 51.003]

Alternative Showerheads

- “Beauty” showerhead dia. 225 mm [cod. 52.001]
- “Evo” showerhead 200 x 200 mm [cod. 52.101]
- “Evo” showerhead dia. 200 mm [cod. 52.003]
- “Flavia” showerhead 75 x 75 mm [cod. 52.102]
- “Loft” showerhead dia. 65 mm [cod. 52.004]
- “Loft” showerhead dia. 70 mm [cod. 52.005]
- “Ocean” showerhead dia. 150 mm [cod. 52.006]
- “Stylo” showerhead 200 x 200 mm [cod. 52.103]
- “Zoe” showerhead 150 x 150 mm [cod. 52.104]

Options

- Satin finish [cod. 55.001]
- Mounting backplate [cod. 50.101]
- Foot rinse (faucet Stella & “Loft” or “Flavia” showerhead) [cod. 54.001]
- Telephone showerhead [cod. 53.001]
- Water service output 1/2” [cod. 56.001]

INOX TYLE

AURORA 4B



INOX TYLE

TECNO
TECNO CUBE
TECNO CUBE 100

TEMPI MODERNI



TECNO

O utdoor shower. Single body, with circular cross section and arm with beveled connector. Also available in the version Beach&Garden with in-ground installation, suitable for beaches and gardens.

AESTHETIC and FUNCTIONAL CHARACTERISTICS

Shower completely made of AISI 316L stainless steel, in both body and screws.

Mirror-like polishing (“Nautical” quality, manually done): less vulnerable to the elements.

No visible screws: reduction of components that are prone to oxidization and wonderful aesthetics.

Invisible mounting: plate cover hides screws on the mounting base; better accident prevention and no limestone or rust deposits.

Showerhead with silicone rubber: anti-limestone and anti-obstruction.

Optional **auxiliary water output** with ½” metal nozzle.

UNIQUE ELEMENTS

Electronic faucet with timer and hydro-massage functions. Aesthetically pleasant and anti-tampering.

Faucet assembly produced exclusively for the shower.

Faucet fully integrated into the shower body. Smaller size and no limestone or rust deposits.

Possibility of quick connection base to more easily remove the shower. Easy storage in the winter months and tamper-proof security.

Customization (text or logos, lights) is possible upon request.





TECNO

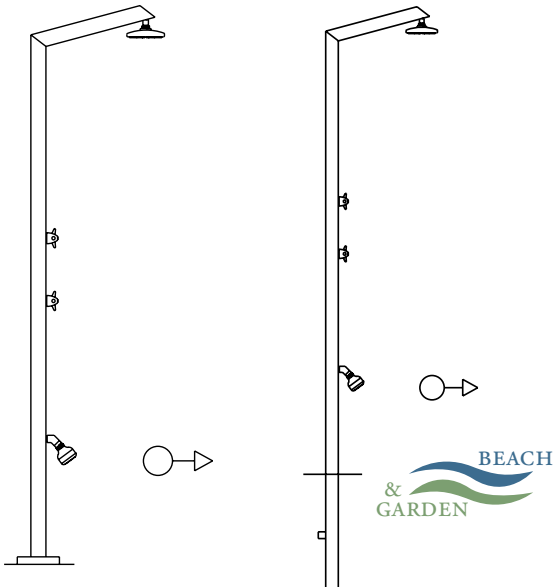

Alternative Faucets

- “Genius” electronic faucet [cod. 51.200]
- Mixer [cod. 51.001]
- Timed flow faucet [cod. 51.003]

Alternative Showerheads

- “Beauty” showerhead dia. 225 mm [cod. 52.001]
- “Disco” showerhead dia. 200 mm [cod. 52.002]
- “Evo” showerhead 200 x 200 mm [cod. 52.101]
- “Evo” showerhead dia. 200 mm [cod. 52.003]
- “Flavia” showerhead 75 x 75 mm [cod. 52.102]
- “Loft” showerhead dia. 65 mm [cod. 52.004]
- “Ocean” showerhead dia. 150 mm [cod. 52.006]
- “Stylo” showerhead 200 x 200 mm [cod. 52.103]
- “Zoe” showerhead 150 x 150 mm [cod. 52.104]

Options

- Satin finish [cod. 55.001]
- Mounting backplate [cod. 50.101]
- Quick connection base [cod. 50.200]
- Foot rinse (faucet Stella & “Loft” or “Flavia” showerhead) [cod. 54.001]
- Telephone showerhead [cod. 53.001]
- Water service output 1/2” [cod. 56.001]

Cod: 01.014

Name: Tecno Shower

Description: Single body, with circular cross section and arm with beveled connector

Standard Configuration

Single body

Faucet: “Stella” faucet [cod. 51.002]

Showerhead: “Loft” showerhead dia. 70 mm [cod. 52.005]

Mounting: Bottom plate dia. 170 mm [cod. 50.004]

Measurements: Body dia. 60 mm

Height 220 cm

Materials: AISI 316L stainless steel, quick connection coupling

Finish: Glossy, mirror-like manual polishing, “nautical” level quality

Hook-up: Water input 1/2”



In-ground Mounting Configuration

Cod: 02.017

Description: In-ground mounting variant

Mounting: In-ground mounting [cod. 50.100]

Measurements: Body dia. 60 mm

Height 300 cm (90 cm in-ground)

INOX TYLE

TECNO



INOX TYLE

TECNO CUBE

Outdoor shower, with square cross section and a single arm with beveled connector. Available also in the version with a double diffuser or dual, T-shaped arms on opposite sides. Also available in the T-shape version with three arm at 90° angles or with four perpendicular arms.

It is also possible to request the Beach&Garden model with in-ground installation suitable for beaches and gardens

AESTHETIC and FUNCTIONAL CHARACTERISTICS

Shower completely made of AISI 316L stainless steel, in both body and screws.

Mirror-like polishing (“Nautical” quality, manually done): less vulnerable to the elements.

No visible screws: reduction of components that are prone to oxidization and wonderful aesthetics.

Invisible mounting: plate cover hides screws on the mounting base: better accident prevention and no limestone or rust deposits.

Showerhead with silicone rubber: anti-limestone and anti-obstruction.

Optional **auxiliary water output** with ½” metal nozzle.

UNIQUE ELEMENTS

Electronic faucet *with timer and hydro-massage functions. Aesthetically pleasant and anti-tampering.*

Faucet assembly *produced exclusively for the shower.*

Faucet fully integrated *into the shower body. Smaller size and no limestone or rust deposits.*

Possibility of quick connection base *to more easily remove the shower. Easy storage in the winter months and tamper-proof security.*

Customization *(text or logos, lights) is possible upon request.*



TECNO CUBE

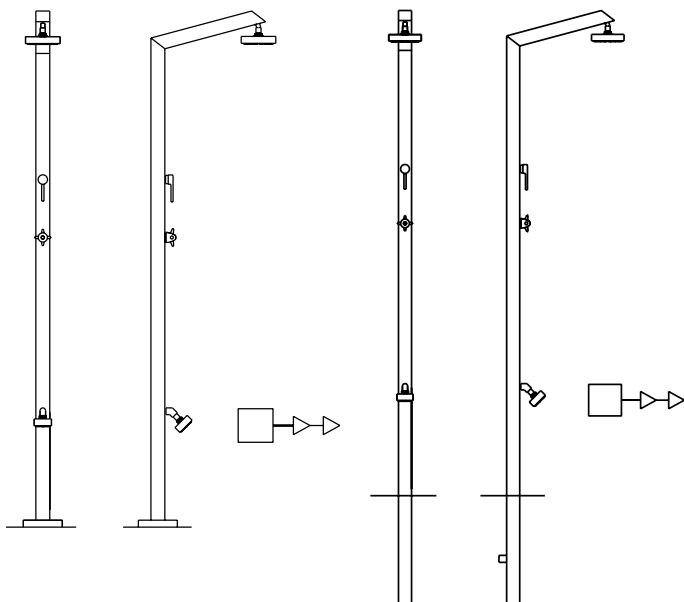

Cod: 01.015

Name: Tecno Cube Shower

Description: Shower, with square cross section and a single arm with beveled connector

Standard Configuration

Single body

Faucet: "Stella" faucet [cod. 51.002]

Showerhead: "Zoe" showerhead 150 x 150 mm [cod. 52.104]

Mounting: Bottom plate 170x170 mm [cod. 50.002]

Measurements: Body 60x60 mm

Height 220 cm

Materials: AISI 316L stainless steel, quick connection coupling system

Finish: Glossy, mirror-like manual polishing, "nautical" level quality

Hook-up: Water input 1/2"

Alternative Faucets

- "Genius" electronic faucet [cod. 51.200]
- Mixer [cod. 51.001]
- Timed flow faucet [cod. 51.003]

Alternative Showerheads

- "Beauty" showerhead dia. 225 mm [cod. 52.001]
- "Disco" showerhead dia. 200 mm [cod. 52.002]
- "Evo" showerhead 200 x 200 mm [cod. 52.101]
- "Evo" showerhead dia. 200 mm [cod. 52.003]
- "Flavia" showerhead 75 x 75 mm [cod. 52.102]
- "Loft" showerhead dia. 65 mm [cod. 52.004]
- "Loft" showerhead dia. 70 mm [cod. 52.005]
- "Ocean" showerhead dia. 150 mm [cod. 52.006]
- "Stylo" showerhead 200 x 200 mm [cod. 52.103]

Options

- Satin finish [cod. 55.001]
- Mounting backplate [cod. 50.101]
- Quick connection base [cod. 50.200]
- Foot rinse (faucet Stella & "Loft" or "Flavia" showerhead) [cod. 54.001]
- Telephone showerhead [cod. 53.001]
- Water service output 1/2" [cod. 56.001]



In-ground Mounting Configuration

Cod: 02.016

Description: In-ground mounting variant

Mounting: In-ground mounting [cod. 50.100]

Measurements: Body 60x60 mm

Height 300 cm (90 cm in-ground)

TECNO CUBE



TECNO CUBE SQUARE

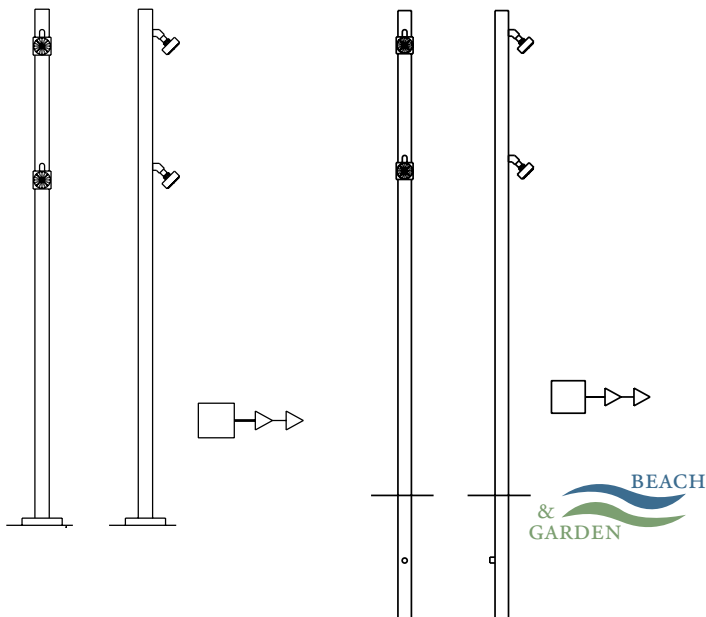

Cod: 01.026

Name: Tecno Cube Square Shower

Description: Shower with a square cross section and double showerhead

Standard Configuration

2 showerheads

Faucet: “Stella” faucet [cod. 51.002]

Showerhead: “Flavia” showerhead 75 x 75 mm [cod. 52.102]

Mounting: Bottom plate 170x170 mm [cod. 50.002]

Measurements: Body 60x60 mm
Height 220 cm

Materials: AISI 316L stainless steel, quick connection coupling system

Finish: Glossy, mirror-like manual polishing, “nautical” level quality

Hook-up: Water input 1/2”

Extra: Photocells columns



In-ground Mounting Configuration

Cod: 02.144

Description: In-ground mounting variant

Mounting: In-ground mounting [cod. 50.100]

Measurements: Body 60x60 mm
Height 300 cm (90 cm in-ground)

Alternative Faucets

- “Genius” electronic faucet [cod. 51.200]
- Mixer [cod. 51.001]
- Timed flow faucet [cod. 51.003]

Alternative Showerheads

- “Beauty” showerhead dia. 225 mm [cod. 52.001]
- “Disco” showerhead dia. 200 mm [cod. 52.002]
- “Evo” showerhead 200 x 200 mm [cod. 52.101]
- “Evo” showerhead dia. 200 mm [cod. 52.003]
- “Loft” showerhead dia. 65 mm [cod. 52.004]
- “Loft” showerhead dia. 70 mm [cod. 52.005]
- “Ocean” showerhead dia. 150 mm [cod. 52.006]
- “Stylo” showerhead 200 x 200 mm [cod. 52.103]
- “Zoe” showerhead 150 x 150 mm [cod. 52.104]

Options

- Satin finish [cod. 55.001]
- Quick connection base [cod. 50.200]
- Foot rinse (faucet Stella & “Loft” or “Flavia” showerhead) [cod. 54.001]
- Telephone showerhead [cod. 53.001]
- Water service output 1/2” [cod. 56.001]

TECNO CUBE SQUARE



TECNO CUBE 100 2B

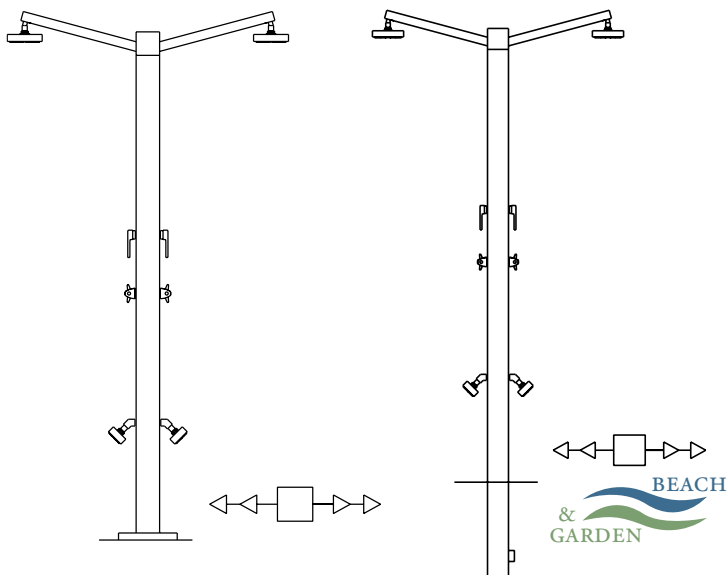

Cod: 01.035

Name: Tecno Cube 100 2B Shower

Description: Shower with a square cross section and double T-shaped arm, opposite to each other

Standard Configuration

Single shower body with two arms

Faucet: “Stella” faucet [cod. 51.002]

Showerhead: “Zoe” showerhead 150 x 150 mm [cod. 52.104]

Mounting: Bottom plate 250x250 mm [cod. 50.003]

Measurements: Main body 100x100 mm, h 220 cm

Shower arms dia. 40 mm

Showerhead height 210 cm

Materials: AISI 316L stainless steel, quick connection coupling system

Finish: Glossy, mirror-like manual polishing, “nautical” level quality

Hook-up: Water input 3/4”

Alternative Faucets

- “Genius” electronic faucet [cod. 51.200]
- Mixer [cod. 51.001]
- Timed flow faucet [cod. 51.003]

Alternative Showerheads

- “Beauty” showerhead dia. 225 mm [cod. 52.001]
- “Disco” showerhead dia. 200 mm [cod. 52.002]
- “Evo” showerhead 200 x 200 mm [cod. 52.101]
- “Evo” showerhead dia. 200 mm [cod. 52.003]
- “Flavia” showerhead 75 x 75 mm [cod. 52.102]
- “Loft” showerhead dia. 65 mm [cod. 52.004]
- “Loft” showerhead dia. 70 mm [cod. 52.005]
- “Ocean” showerhead dia. 150 mm [cod. 52.006]
- “Stylo” showerhead 200 x 200 mm [cod. 52.103]

Options

- Satin finish [cod. 55.001]
- Mounting backplate [cod. 50.101]
- Foot rinse (faucet Stella & “Loft” or “Flavia” showerhead) [cod. 54.001]
- Telephone showerhead [cod. 53.001]
- Water service output 1/2” [cod. 56.001]



In-ground Mounting Configuration

Cod: 02.148

Description: In-ground mounting variant

Mounting: In-ground mounting [cod. 50.100]

Measurements: Main body 100x100 mm,
h 300 cm (90 cm in-ground)
Shower arms dia. 40 mm

TECNO CUBE 100 2B



TECNO CUBE 100 3B

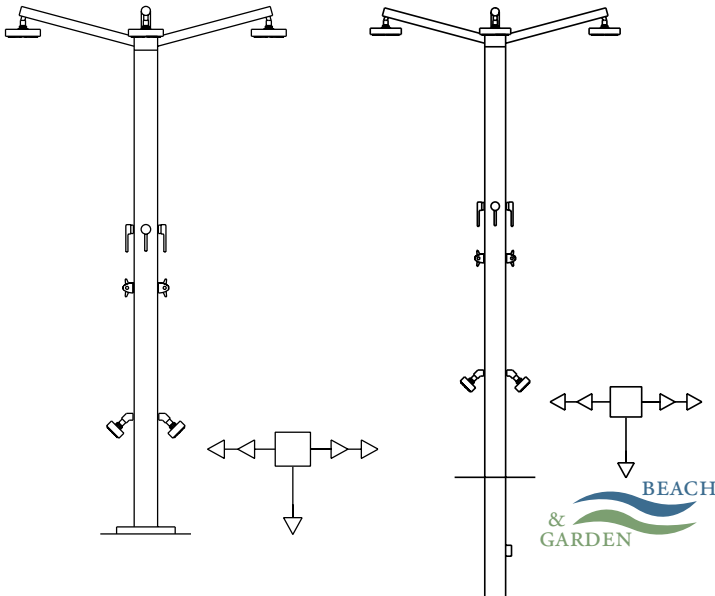

Alternative Faucets

- “Genius” electronic faucet [cod. 51.200]
- Mixer [cod. 51.001]
- Timed flow faucet [cod. 51.003]

Alternative Showerheads

- “Beauty” showerhead dia. 225 mm [cod. 52.001]
- “Disco” showerhead dia. 200 mm [cod. 52.002]
- “Evo” showerhead 200 x 200 mm [cod. 52.101]
- “Evo” showerhead dia. 200 mm [cod. 52.003]
- “Flavia” showerhead 75 x 75 mm [cod. 52.102]
- “Loft” showerhead dia. 65 mm [cod. 52.004]
- “Loft” showerhead dia. 70 mm [cod. 52.005]
- “Ocean” showerhead dia. 150 mm [cod. 52.006]
- “Stylo” showerhead 200 x 200 mm [cod. 52.103]

Options

- Satin finish [cod. 55.001]
- Mounting backplate [cod. 50.101]
- Foot rinse (faucet Stella & “Loft” or “Flavia” showerhead) [cod. 54.001]
- Telephone showerhead [cod. 53.001]
- Water service output 1/2” [cod. 56.001]

Cod: 01.037

Name: Tecno Cube 100 3B Shower

Description: T-shaped shower with a square cross section with three arms at 90°

Standard Configuration

Single shower body with three arms

Faucet: “Stella” faucet [cod. 51.002]

Showerhead: “Zoe” showerhead 150 x 150 mm [cod. 52.104]

Mounting: Bottom plate 250x250 mm [cod. 50.003]

Measurements: Main body 100x100 mm, h 220 cm
Shower arms dia. 40 mm
Showerhead height 210 cm

Materials: AISI 316L stainless steel, quick connection coupling system

Finish: Glossy, mirror-like manual polishing, “nautical” level quality

Hook-up: Water input 3/4”



In-ground Mounting Configuration

Cod: 02.149

Description: In-ground mounting variant

Mounting: In-ground mounting [cod. 50.100]

Measurements: Main body 100x100 mm,
h 300 cm (90 cm in-ground)
Shower arms dia. 40 mm

TECNO CUBE 100 3B

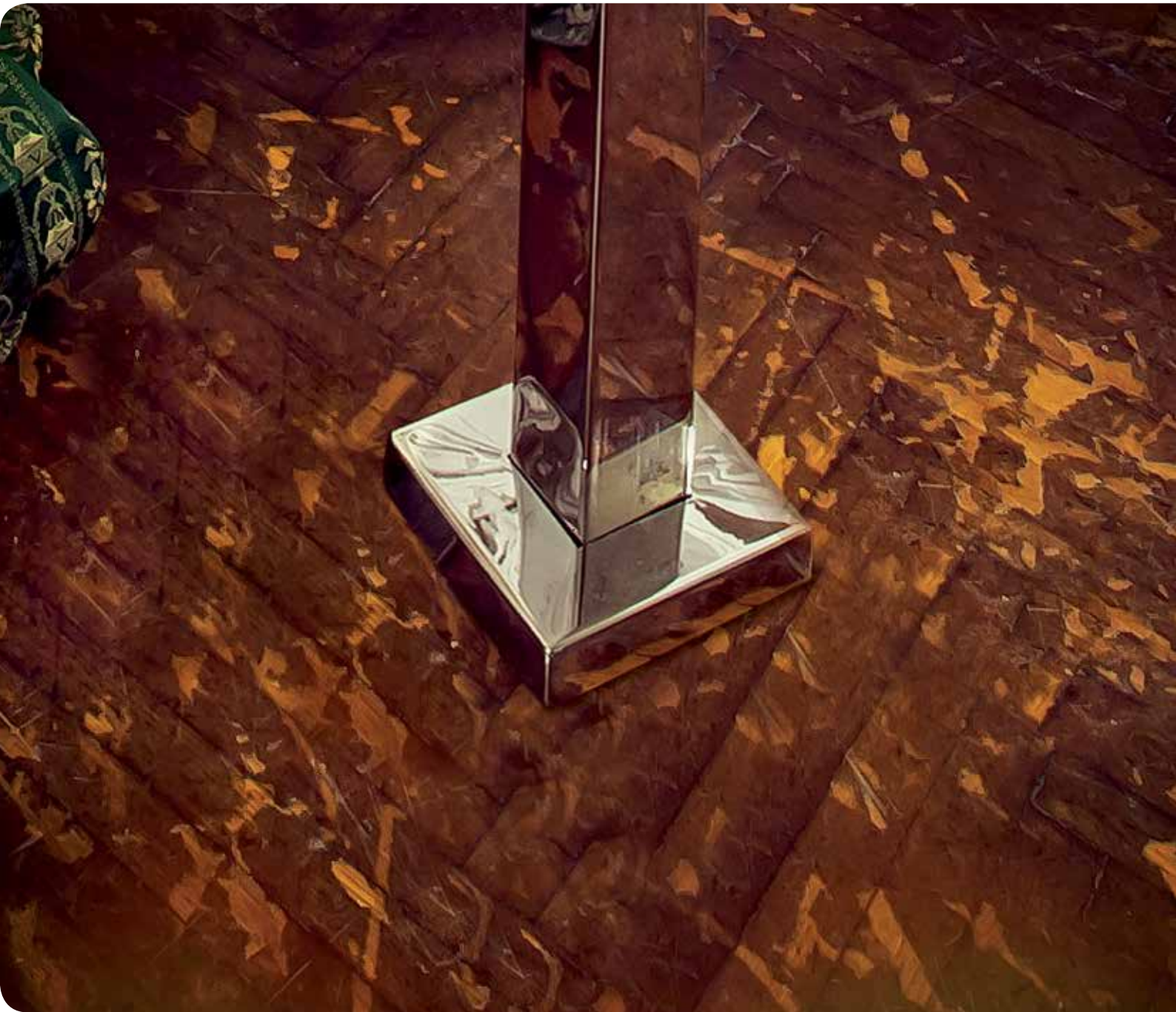

TECNO CUBE 100 4B

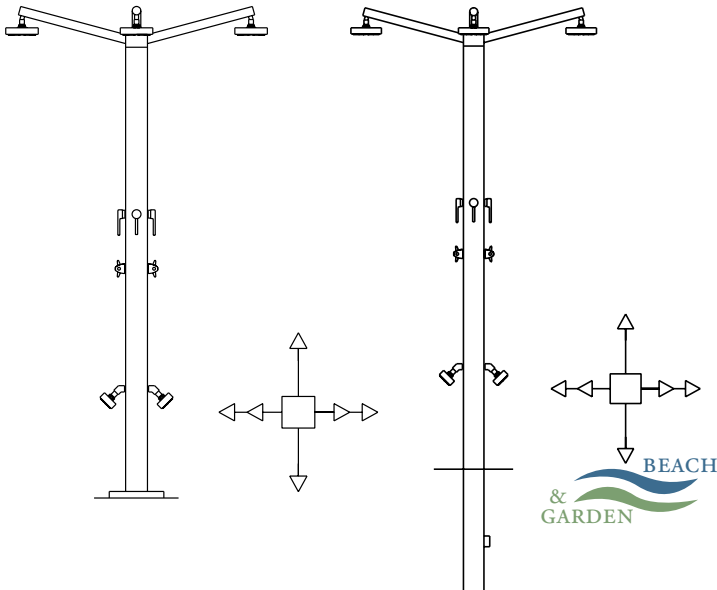

Cod: 01.147

Name: Tecno Cube 100 4B Shower

Description: T-shaped shower with a square cross section, with four perpendicular arms

Standard Configuration

Single shower body with four arms

Faucet: “Stella” faucet [cod. 51.002]

Showerhead: “Zoe” showerhead 150 x 150 mm [cod. 52.104]

Mounting: Bottom plate 250x250 mm [cod. 50.003]

Measurements: Main body 100x100 mm, h 220 cm

Shower arms dia. 40 mm

Showerhead height 210 cm

Materials: AISI 316L stainless steel, quick connection coupling system

Finish: Glossy, mirror-like manual polishing, “nautical” level quality

Hook-up: Water input 3/4”



In-ground Mounting Configuration

Cod: 02.150

Description: In-ground mounting variant

Mounting: In-ground mounting [cod. 50.100]

Measurements: Main body 100x100 mm,
h 300 cm (90 cm in-ground)
Shower arms dia. 40 mm

Alternative Faucets

- “Genius” electronic faucet [cod. 51.200]
- Mixer [cod. 51.001]
- Timed flow faucet [cod. 51.003]

Alternative Showerheads

- “Beauty” showerhead dia. 225 mm [cod. 52.001]
- “Disco” showerhead dia. 200 mm [cod. 52.002]
- “Evo” showerhead 200 x 200 mm [cod. 52.101]
- “Evo” showerhead dia. 200 mm [cod. 52.003]
- “Flavia” showerhead 75 x 75 mm [cod. 52.102]
- “Loft” showerhead dia. 65 mm [cod. 52.004]
- “Loft” showerhead dia. 70 mm [cod. 52.005]
- “Ocean” showerhead dia. 150 mm [cod. 52.006]
- “Stylo” showerhead 200 x 200 mm [cod. 52.103]

Options

- Satin finish [cod. 55.001]
- Mounting backplate [cod. 50.101]
- Foot rinse (faucet Stella & “Loft” or “Flavia” showerhead) [cod. 54.001]
- Telephone showerhead [cod. 53.001]
- Water service output 1/2” [cod. 56.001]

TECNO CUBE 100 4B



NIAGARA
COLORADO
BIRDY
TELEPHONE
PELLICANO

BEAUTY STANDS OUT





NIAGARA

Single body fountain, with a circular cross section, with circular collection tank. Also available in a version without collection tank. Also available in the version with a square cross section.

AESTHETIC and FUNCTIONAL CHARACTERISTICS

Completely in stainless steel AISI 316L, in both body and screws.

Mirror-like polishing (“Nautical” quality, manually done): less vulnerable to the elements.

Very few visible screws: reduction of components prone to oxidation.

Optional auxiliary water output with ½” metal nozzle.

UNIQUE ELEMENTS

Faucet assembly produced exclusively for the fountain..

Faucet fully integrated con il Body della Fountain. Absence of limestone or rust deposits.

Electronic faucet with timer function. Aesthetically pleasant and anti-tampering.

Possibility of quick connection base to move the fountain more easily. Easy storage in the winter months and tamper-proof security.





FOX STYLE

NIAGARA

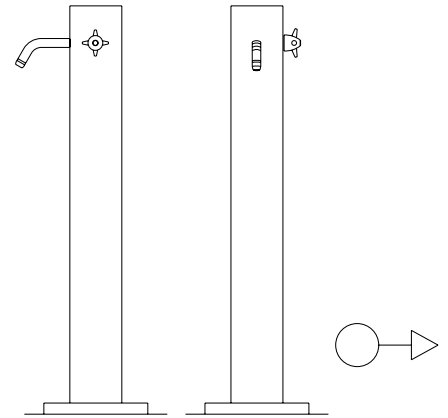

Cod: 05.008

Name: Niagara Fountain

Description: Single body fountain, with a circular cross section

Standard Configuration

Fountain

Faucet: Timed flow faucet [cod. 51.003]

Mounting: Bottom plate dia. 280 mm [cod. 50.005]

Measurements: Main body dia. 140 mm

Height tot. 110 cm

Materials: AISI 316L stainless steel, quick connection coupling system

Finish: Glossy, mirror-like manual polishing, "nautical" level quality

Hook-up: Water input 1/2"

Alternative Faucets

- Electronic faucet (ON/OFF switch) [cod. 51.100]
- "Stella" faucet [cod. 51.002]

Options

- Satin finish [cod. 55.001]
- In-ground mounting [cod. 50.100]
- Water service output 1/2" [cod. 56.001]

INOX TYLE

NIAGARA



INOX TYLE

NIAGARA CUBE

Cod: 05.021

Name: Niagara Cube Fountain

Description: Single body fountain, with a square cross section

Standard Configuration

Fountain

Faucet: Timed flow faucet [cod. 51.003]

Mounting: Bottom plate 170x170 mm [cod. 50.002]

Measurements: Main body 100x100 mm

Height tot. 110 cm

Materials: AISI 316L stainless steel, quick connection coupling system

Finish: Glossy, mirror-like manual polishing, "nautical" level quality

Hook-up: Water input 1/2"

Alternative Faucets

- Electronic faucet (ON/OFF switch) [cod. 51.100]
- "Stella" faucet [cod. 51.002]

Options

- Satin finish [cod. 55.001]
- In-ground mounting [cod. 50.100]
- Water service output 1/2" [cod. 56.001]

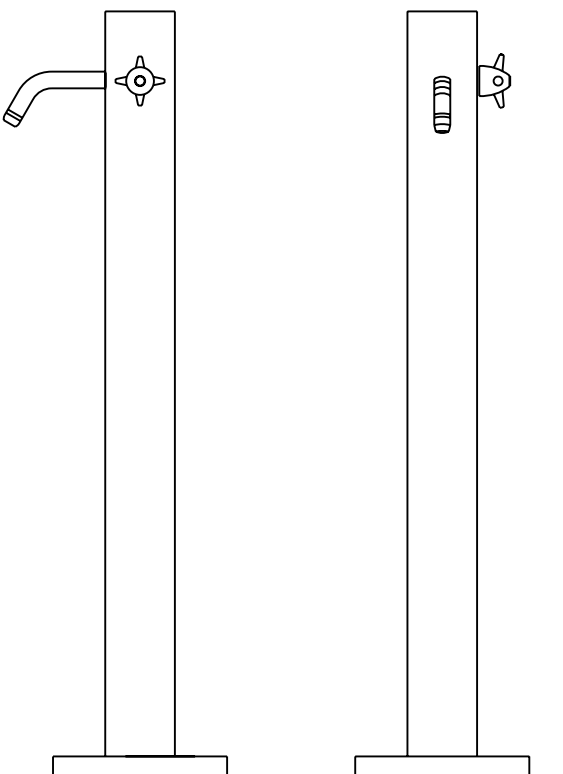

NIAGARA CUBE

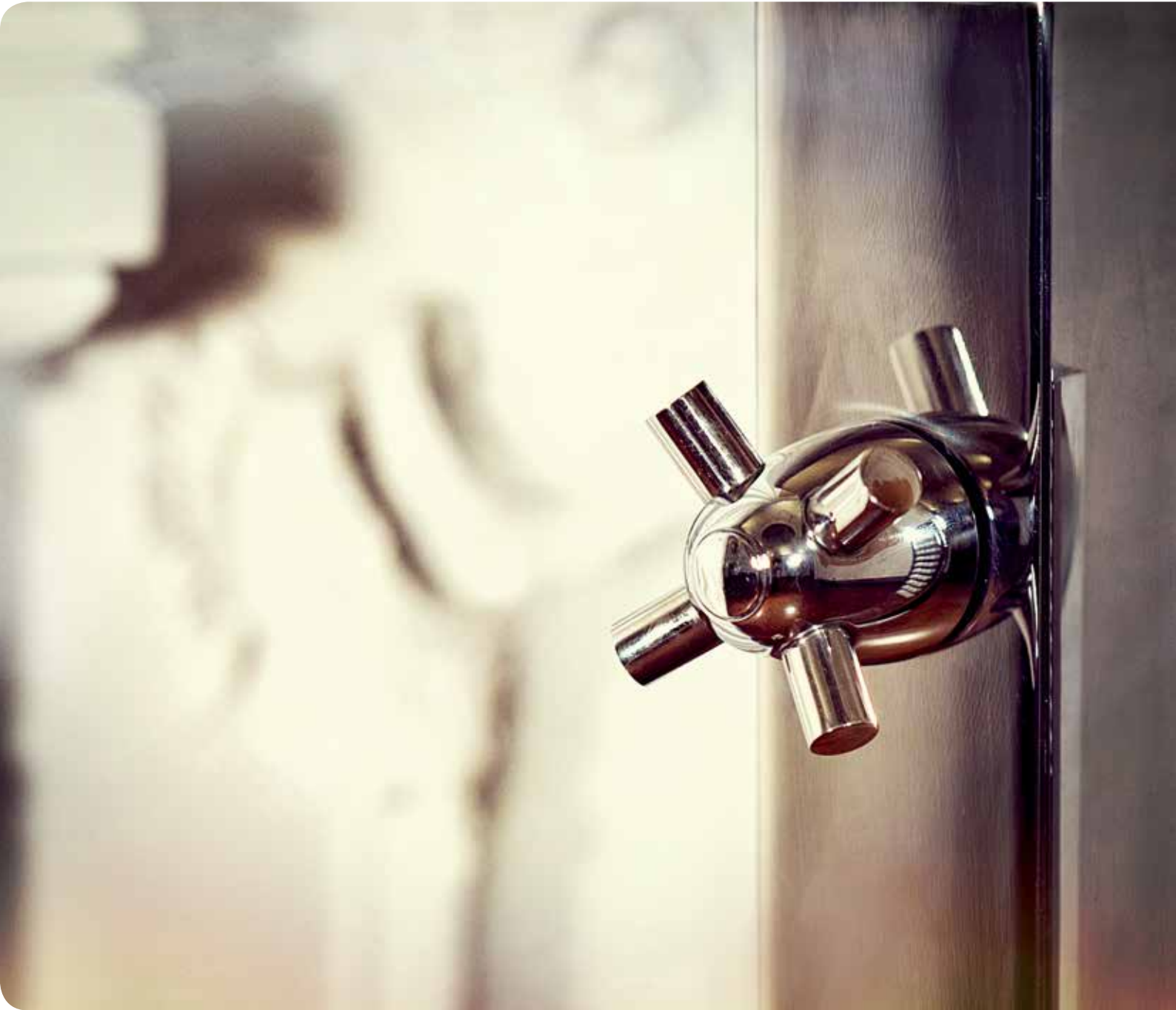

NIAGARA RIO

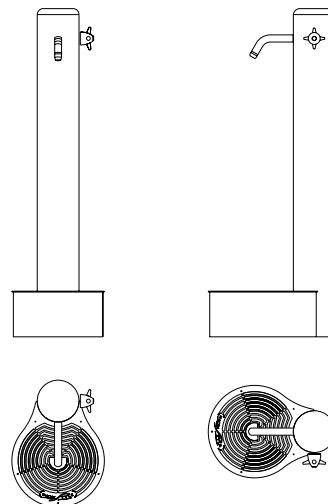

Cod: 05.029

Name: Niagara Rio Fountain

Description: Single body fountain, with a circular cross section with circular collection tank

Standard Configuration

Fountain with a collection basin

Faucet: Timed flow faucet [cod. 51.003]

Mounting: Visible mounting

Measurements: Main body dia.140 mm, h 110 cm
Water collection tank dia. 300

Materials: AISI 316L stainless steel, quick connection coupling system

Finish: Glossy, mirror-like manual polishing, "nautical" level quality

Hook-up: Water input 1/2"

Alternative Faucets

- Electronic faucet (ON/OFF switch) [cod. 51.100]
- "Stella" faucet [cod. 51.002]

Options

- Satin finish [cod. 55.001]
- Water service output 1/2" [cod. 56.001]

NIAGARA RIO



COLORADO

Single body fountain, with a square cross section, with square collection tank with cylindrical edges.

AESTHETIC and FUNCTIONAL CHARACTERISTICS

Fountain Completely in stainless steel AISI 316L, in both body and screws.

Mirror-like polishing (“Nautical” quality, manually done): less vulnerable to the elements.

Very few visible screws: reduction of components prone to oxidation.

Optional **auxiliary water output** with ½” metal nozzle.

UNIQUE ELEMENTS

Electronic faucet *with timer function.*
Aesthetically pleasant and anti-tampering.





COLORADO

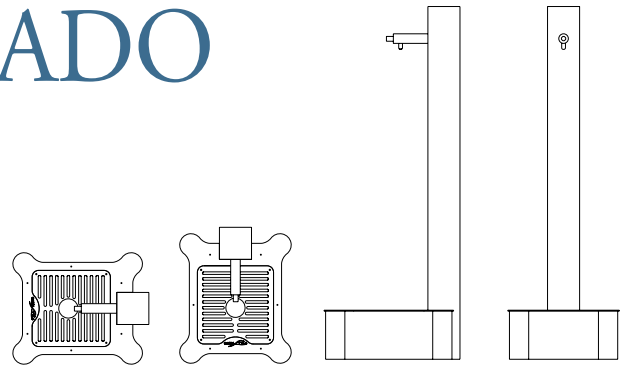

Cod: 05.030

Name: Colorado Fountain

Description: Single body fountain, with a square cross section, with square collection tank with cylindrical edges.

Standard Configuration

Fountain with a collection basin

Faucet: Timed flow faucet [cod. 51.003]

Mounting: Floor mounting

Measurements: Main body 100X100 mm

Height tot. 110 cm

Water collection tank 430X350 mm

Materials: AISI 316L stainless steel, quick connection coupling system

Finish: Glossy, mirror-like manual polishing, "nautical" level quality

Hook-up: Water input 1/2"

Alternative Faucets

- Electronic faucet (ON/OFF switch) [cod. 51.100]
- "Stella" faucet [cod. 51.002]

Options

- Satin finish [cod. 55.001]
- Water service output 1/2" [cod. 56.001]

COLORADO



BIRDY

Single body, birdbath shaped fountain, with a circular cross section.

AESTHETIC and FUNCTIONAL CHARACTERISTICS

Fountain Completely in stainless steel AISI 316L, in both body and screws.

Mirror-like polishing (“Nautical” quality, manually done): less vulnerable to the elements.

Very few visible screws: reduction of components prone to oxidation.

Optional **auxiliary water output** with ½” metal nozzle.

UNIQUE ELEMENTS

Electronic faucet *with timer function.*
Aesthetically pleasant and anti-tampering.





BIRDY

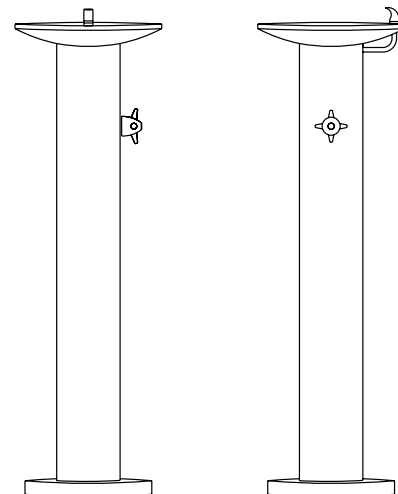
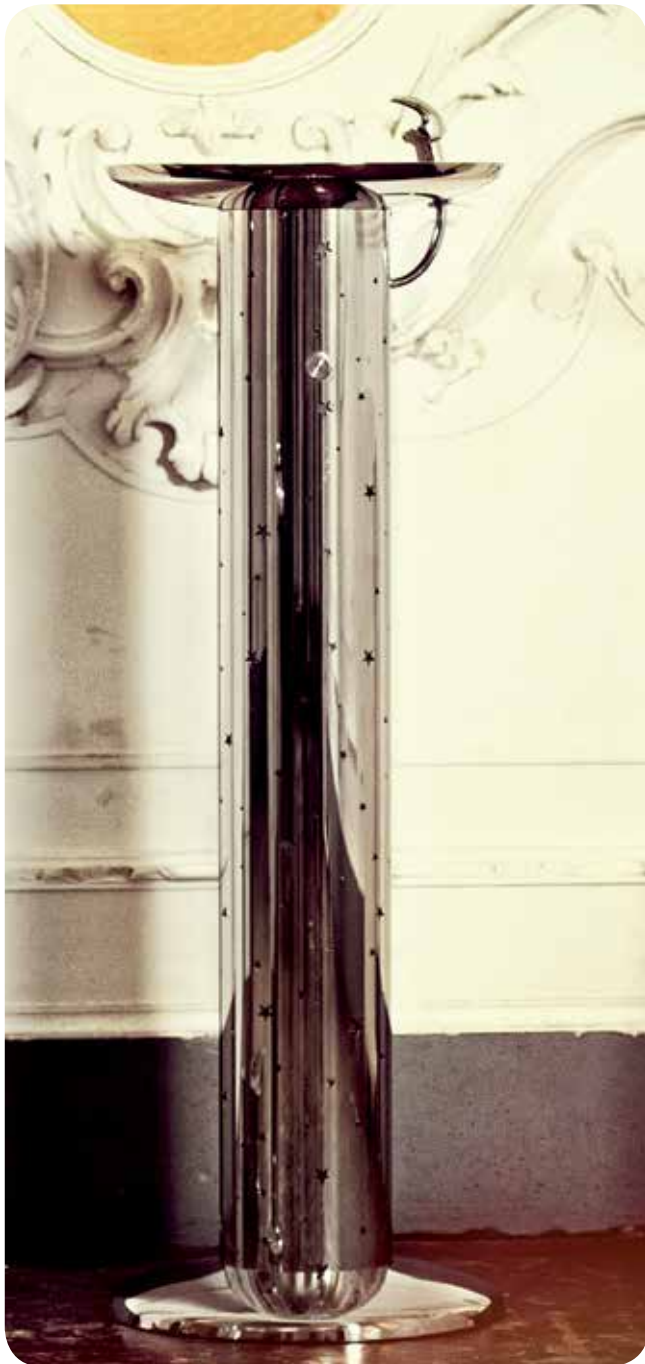

Cod: 05.062

Name: Birdy Fountain

Description: Single body fountain, birdbath shaped fountain, with a circular cross section

Standard Configuration

Faucet: Fountain

Mounting: "Stella" faucet [cod. 51.002]

Measurements: Bottom plate dia. 280 mm [cod. 50.005]

Materials: Body dia. 140 mm, h 110 cm
AISI 316L stainless steel, quick connection coupling system

Finish: Glossy, mirror-like manual polishing, "nautical"

Hook-up: level quality
Water input 1/2"

Alternative Faucets

- Electronic faucet (ON/OFF switch) [cod. 51.100]
- "Stella" faucet [cod. 51.002]

Options

- Satin finish [cod. 55.001]
- In-ground mounting [cod. 50.100]
- Water service output 1/2" [cod. 56.001]

BIRDY



TELEPHONE COLUMN

Column, with a circular cross section, with handshower. Also available in a version with dispenser button. It is also possible to request the model with a square cross section and handshower, with or without dispenser button.

AESTHETIC and FUNCTIONAL CHARACTERISTICS

Column Completely in stainless steel AISI 316L, in both body and screws.

Mirror-like polishing (“Nautical” quality, manually done): less vulnerable to the elements.

Very few visible screws: reduction of components prone to oxidation.

Invisible mounting plate cover hides screws on the mounting base: better accident prevention and no limestone or rust deposits.

Showerhead with silicone rubber: anti-limestone and anti-obstruction.

Optional auxiliary water output with ½” metal nozzle.

UNIQUE ELEMENTS

Faucet assembly produced exclusively for the column.

Faucet fully integrated with the body of the column. Smaller size and no limestone or rust deposits.

Electronic faucet with timer and hydro-massage functions. Aesthetically pleasant and anti-tampering.

Customization (text or logos, lights) is possible upon request.





TELEPHONE

Cod: 04.023

Name: Telephone Column

Description: Column, with a circular cross section, with handshower

Standard Configuration

Column

Faucet: "Stella" faucet [cod. 51.002]

Showerhead: Telephone showerhead [cod. 53.001]

Mounting: Bottom plate dia. 170 mm [cod. 50.004]

Measurements: Body dia. 76 mm

Height tot. 100 cm

Materials: AISI 316L stainless steel, quick connection coupling system

Finish: Glossy, mirror-like manual polishing, "nautical" level quality

Hook-up: Water input 1/2"

Alternative Faucets

- Electronic faucet (Brewing switch) [cod. 51.100]
- Mixer [cod. 51.001]
- "Stella" faucet [cod. 51.002]
- Timed flow faucet [cod. 51.003]

Options

- Satin finish [cod. 55.001]
- In-ground mounting [cod. 50.100]
- Water service output 1/2" [cod. 56.001]

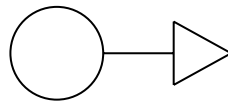
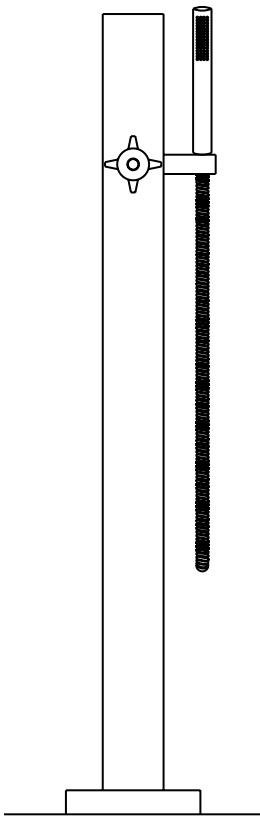

TELEPHONE



TELEPHONE CUBE

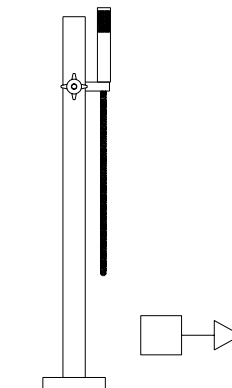

Cod: 04.024

Name: Telephone Cube Column

Description: Column, with a square cross section, with handshower

Standard Configuration

Column

Faucet: "Stella" faucet [cod. 51.002]

Showerhead: Telephone showerhead [cod. 53.001]

Mounting: Bottom plate 170x170 mm [cod. 50.002]

Measurements: Body 60x60 mm

Height tot. 100 cm

Materials: AISI 316L stainless steel, quick connection coupling system

Finish: Glossy, mirror-like manual polishing, "nautical" level quality

Hook-up: Water input 1/2"

Alternative Faucets

- Electronic faucet (Brewing switch) [cod. 51.100]
- Mixer [cod. 51.001]
- Faucet "Stella" [cod. 51.002]
- Timed flow faucet [cod. 51.003]

Options

- Satin finish [cod. 55.001]
- In-ground mounting [cod. 50.100]
- Water service output 1/2" [cod. 56.001]

TELEPHONE CUBE



SHUT OFF

Cod: 04.013

Name: Shut off Column

Description: Column, with a circular cross section, with handshower with dispenser button

Standard Configuration

Column, with handshower with dispenser (button) included

Faucet: Handshower Shut-off

Showerhead: Telephone showerhead [cod. 53.002]

Mounting: Bottom plate dia. 170 mm [cod. 50.004]

Measurements: Body dia. 76 mm

Height tot. 100 cm

Materials: AISI 316L stainless steel, quick connection coupling system

Finish: Glossy, mirror-like manual polishing, “nautical” level quality

Hook-up: Water input 1/2”

Alternative Faucets

- Electronic faucet (Brewing switch) [cod. 51.100]
- Mixer [cod. 51.001]
- “Stella” faucet [cod. 51.002]
- Timed flow faucet [cod. 51.003]

Options

- Satin finish [cod. 55.001]
- In-ground mounting [cod. 50.100]
- Water service output 1/2” [cod. 56.001]

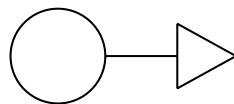
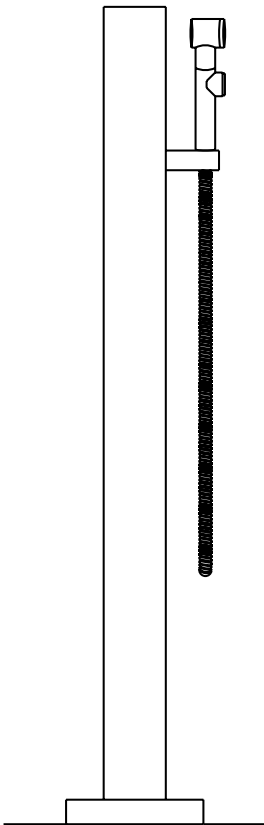

SHUT OFF



SHUT OFF CUBE

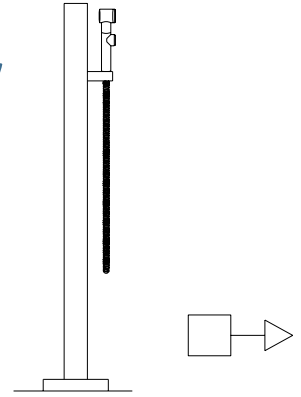

Cod: 04.014

Name: Shut off Cube Column

Description: Column, with a square cross section, with handshower with dispenser button

Standard Configuration

Column, with handshower with dispenser (button) included

Faucet: Handshower Shut-off

Showerhead: Telephone showerhead [cod. 53.002]

Mounting: Bottom plate 170x170 mm [cod. 50.002]

Measurements: Body 60x60 mm

Height tot. 100 cm

Materials: AISI 316L stainless steel, quick connection coupling system

Finish: Glossy, mirror-like manual polishing, "nautical" level quality

Hook-up: Water input 1/2"

Alternative Faucets

- Electronic faucet (Brewing switch) [cod. 51.100]
- Mixer [cod. 51.001]
- "Stella" faucet [cod. 51.002]
- Timed flow faucet [cod. 51.003]

Options

- Satin finish [cod. 55.001]
- In-ground mounting [cod. 50.100]
- Water service output 1/2" [cod. 56.001]

SHUT OFF CUBE



PELLICANO

Foot washer with circular cross section. Also available in a version with double diffuser, opposite to each other. It is also possible to request the model with a square cross section, with or without the double diffuser, opposite to each other.

AESTHETIC and FUNCTIONAL CHARACTERISTICS

Column Completely in stainless steel AISI 316L, in both body and screws.

Mirror-like polishing (“Nautical” quality, manually done): less vulnerable to the elements.

Very few visible screws: reduction of components prone to oxidation.

Invisible mounting plate cover hides screws on the mounting base: better accident prevention and no limestone or rust deposits.

Showerhead with silicone rubber: anti-limestone and anti-obstruction.

Optional auxiliary water output with ½” metal nozzle.

UNIQUE ELEMENTS

Faucet assembly produced exclusively for the column.

Faucet fully integrated into the shower body. Smaller size and no limestone or rust deposits.

Electronic faucet with timer and hydro-massage functions. Aesthetically pleasant and anti-tampering.

Customization (text or logos, lights) is possible upon request.



FOOT RINSE PELLICANO

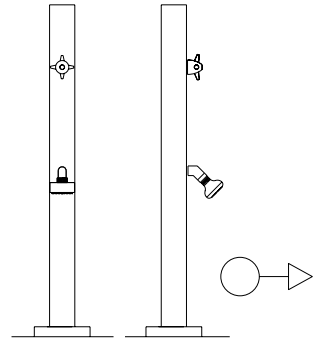

Cod: 06.009

Name: Pellicano Foot rinse

Description: Foot washer with a circular cross section

Standard Configuration

Foot rinse

Faucet: "Stella" faucet [cod. 51.002]

Showerhead: "Loft" showerhead dia. 70 mm [cod. 52.005]

Mounting: Bottom plate dia. 170 mm [cod. 50.004]

Measurements: Body dia. 76 mm

Height tot. 100 cm

Materials: AISI 316L stainless steel, quick connection coupling system

Finish: Glossy, mirror-like manual polishing, "nautical" level quality

Hook-up: Water input 1/2"

Extra: Tank for draining water

Alternative Faucets

- Electronic faucet (Brewing switch) [cod. 51.100]
- Mixer [cod. 51.001]
- Timed flow faucet [cod. 51.003]

Options

- Satin finish [cod. 55.001]
- Mounting backplate [cod. 50.101]
- In-ground mounting [cod. 50.100]
- Telephone showerhead [cod. 53.001]
- Water service output 1/2" [cod. 56.001]

FOOT RINSE PELLICANO



FOOT RINSE PELLICANO DUO

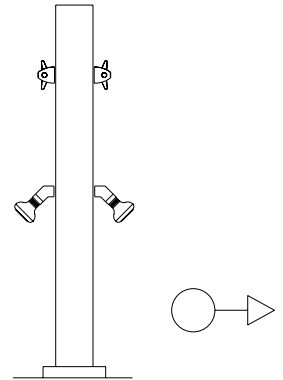

Cod: 06.063

Name: Pellicano Duo Foot rinse

Description: Foot washer with a circular cross section with double diffuser opposite to each other

Standard Configuration

2 showerheads, opposite to each other

Faucet: "Stella" faucet [cod. 51.002]

Showerhead: "Loft" showerhead dia. 70 mm [cod. 52.005]

Mounting: Bottom plate dia. 170 mm [cod. 50.004]

Measurements: Body dia. 100 mm

Height tot. 100 cm

Materials: AISI 316L stainless steel, quick connection coupling system

Finish: Glossy, mirror-like manual polishing, "nautical" level quality

Hook-up: Water input 1/2"

Alternative Faucets

- Electronic faucet (Brewing switch) [cod. 51.100]
- Mixer [cod. 51.001]
- Timed flow faucet [cod. 51.003]

Options

- Satin finish [cod. 55.001]
- In-ground mounting [cod. 50.100]
- Telephone showerhead [cod. 53.001]
- Water service output 1/2" [cod. 56.001]

FOOT RINSE PELLICANO DUO



FOOT RINSE PELLICANO CUBE

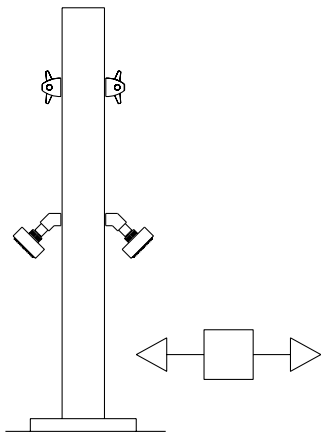

Cod: 06.033

Name: Pellicano Cube Duo Foot rinse

Description: Foot washer with a square cross section with double diffuser, opposite to each other

Standard Configuration

2 showerheads, opposite to each other

Faucet: "Stella" faucet [cod. 51.002]

Showerhead: "Flavia" showerhead 75 x 75 mm [cod. 52.102]

Mounting: Bottom plate 170x170 mm [cod. 50.002]

Measurements: Body 100x100 mm
Height tot. 100 cm

Materials: AISI 316L stainless steel, quick connection coupling system

Finish: Glossy, mirror-like manual polishing, "nautical" level quality

Hook-up: Water input 1/2"

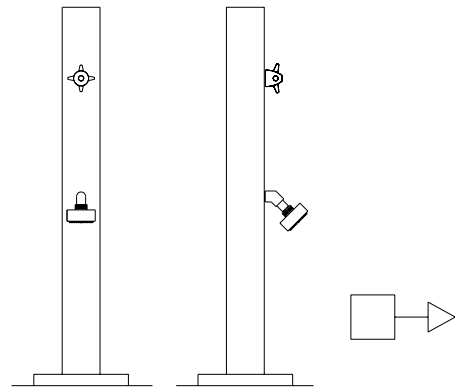

Cod: 06.032

Name: Pellicano Cube Foot rinse

Description: Foot washer with a square cross section

Standard Configuration

Foot rinse

Faucet: "Stella" faucet [cod. 51.002]

Showerhead: "Flavia" showerhead 75 x 75 mm [cod. 52.102]

Mounting: Bottom plate 170x170 mm [cod. 50.002]

Measurements: Body 100x100 mm
Height tot. 100 cm

Materials: AISI 316L stainless steel,
quick coupling fitting system

Finish: Glossy, mirror-like manual polishing, "nautical" level quality

Hook-up: Water input 1/2"

Alternative Faucets

- Electronic faucet (Brewing switch) [cod. 51.100]
- Mixer [cod. 51.001]
- Timed flow faucet [cod. 51.003]

Options

- Satin finish [cod. 55.001]
- In-ground mounting [cod. 50.100]
- Telephone showerhead [cod. 53.001]
- Water service output 1/2" [cod. 56.001]

FOOT RINSE PELLICANO CUBE



BROOKLYN
CUBE
RUBINO
MIND THE GAP





BROOKLYN

Shower archway, with a circular cross section, with two inclined diffusers.
It is also possible to request the model with a square cross section, with three diffusers, or with a circular cross section, with three diffusers.

AESTHETIC and FUNCTIONAL CHARACTERISTICS

Shower a varco Completely in stainless steel AISI 316L, in both body and screws.

Mirror-like polishing (“Nautical” quality, manually done): less vulnerable to the elements.

Very few visible screws: reduction of components prone to oxidation.

Invisible mounting plate cover hides screws on the mounting base: better accident prevention and no limestone or rust deposits.

Showerhead with silicone rubber: anti-limestone and anti-obstruction.

Optional auxiliary water output with ½” metal nozzle.

UNIQUE ELEMENTS

Electronic faucet *with timer and hydro-massage functions. Aesthetically pleasant and anti-tampering.*

Customization *(text or logos, lights) is possible upon request.*



BROOKLYN

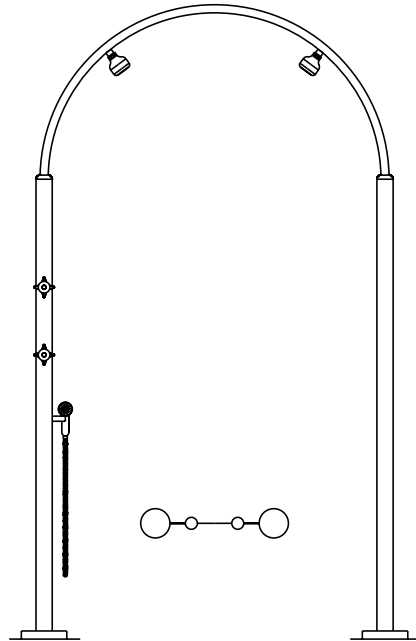

Alternative Faucets

- “Genius” electronic faucet [cod. 51.200]
- Mixer [cod. 51.001]
- “Stella” faucet [cod. 51.002]
- Timed flow faucet [cod. 51.003]

Alternative Showerheads

- “Beauty” showerhead dia. 225 mm [cod. 52.001]
- “Disco” showerhead dia. 200 mm [cod. 52.002]
- “Evo” showerhead 200 x 200 mm [cod. 52.101]
- “Evo” showerhead dia. 200 mm [cod. 52.003]
- “Flavia” showerhead 75 x 75 mm [cod. 52.102]
- “Loft” showerhead dia. 65 mm [cod. 52.004]
- “Ocean” showerhead dia. 150 mm [cod. 52.006]
- “Stylo” showerhead 200 x 200 mm [cod. 52.103]
- “Zoe” showerhead 150 x 150 mm [cod. 52.104]

Options

- Satin finish [cod. 55.001]
- Mounting backplate [cod. 50.101]
- Foot rinse (faucet Stella & “Loft” or “Flavia” showerhead) [cod. 54.001]
- Telephone showerhead [cod. 53.001]
- Water service output 1/2” [cod. 56.001]

Cod: 03.012

Name: Shower archway Brooklyn

Description: Shower archway with a circular cross section with two inclined diffusers

Standard Configuration

2 showerheads - Main body dia. 60 mm.

Showerhead: “Loft” showerhead dia. 70 mm [cod. 52.005]

Mounting: Bottom plate dia. 170 mm [cod. 50.004]

Measurements: Main body dia. 60 mm,
Arc dia. 30 mm, Height tot. 230 cm,
Archway width 120cm

Materials: AISI 316L stainless steel

Finish: Glossy, mirror-like manual polishing, “nautical” level quality

Hook-up: Water input 1/2” a sinistra

Extra: In-ground mounting
Photocells columns

BROOKLYN



CUBE

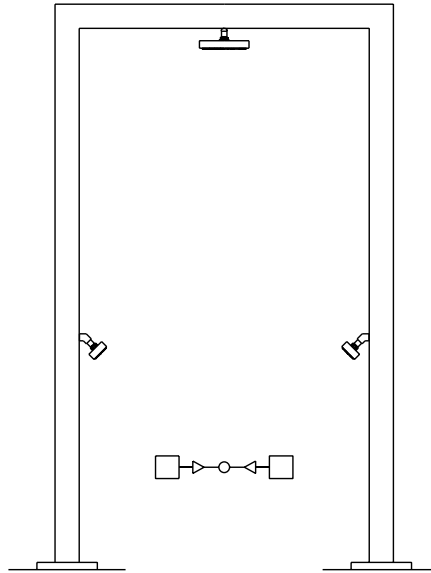

Alternative Faucets

- “Genius” electronic faucet [cod. 51.200]
- Mixer [cod. 51.001]
- “Stella” faucet [cod. 51.002]
- Timed flow faucet [cod. 51.003]

Alternative Showerheads

- “Beauty” showerhead dia. 225 mm [cod. 52.001]
- “Disco” showerhead dia. 200 mm [cod. 52.002]
- “Evo” showerhead 200 x 200 mm [cod. 52.101]
- “Evo” showerhead dia. 200 mm [cod. 52.003]
- “Flavia” showerhead 75 x 75 mm [cod. 52.102]
- “Loft” showerhead dia. 65 mm [cod. 52.004]
- “Loft” showerhead dia. 70 mm [cod. 52.005]
- “Ocean” showerhead dia. 150 mm [cod. 52.006]
- “Stylo” showerhead 200 x 200 mm [cod. 52.103]
- “Zoe” showerhead 150 x 150 mm [cod. 52.104]

Options

- Satin finish [cod. 55.001]
- Mounting backplate [cod. 50.101]
- Foot rinse (faucet Stella & “Loft” or “Flavia” showerhead) [cod. 54.001]
- Telephone showerhead [cod. 53.001]
- Water service output 1/2” [cod. 56.001]

Cod: 03.033

Name: Shower archway Cube

Description: Shower archway with a square cross section with three diffusers

Standard Configuration

1 “Evo” showerhead 200x200 + 2 lateral showerheads Flavia 75x75 - No Faucet (see options)

Showerhead: “Evo” showerhead 200 x 200 mm [cod. 52.101]

Mounting: Bottom plate dia. 170 mm [cod. 50.004]

Measurements: Main body 100x100 mm, h 230

Archway width 120cm

Materials: AISI 316L stainless steel

Finish: Glossy, mirror-like manual polishing, “nautical” level quality

Hook-up: Water input 1/2” bilateral
Photocells columns

Extra: Alternative: single central diffuser.

INOX TYLE

CUBE



INOX TYLE

RUBINO S₃

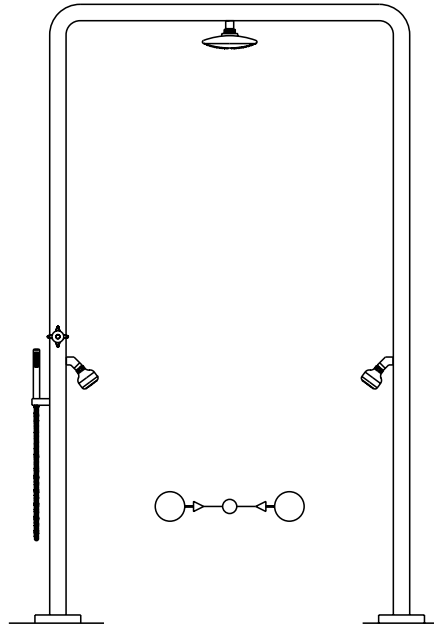

Alternative Faucets

- “Genius” electronic faucet [cod. 51.200]
- Mixer [cod. 51.001]
- “Stella” faucet [cod. 51.002]
- Timed flow faucet [cod. 51.003]

Alternative Showerheads

- “Beauty” showerhead dia. 225 mm [cod. 52.001]
- “Disco” showerhead dia. 200 mm [cod. 52.002]
- “Evo” showerhead 200 x 200 mm [cod. 52.101]
- “Evo” showerhead dia. 200 mm [cod. 52.003]
- “Flavia” showerhead 75 x 75 mm [cod. 52.102]
- “Loft” showerhead dia. 65 mm [cod. 52.004]
- “Loft” showerhead dia. 70 mm [cod. 52.005]
- “Ocean” showerhead dia. 150 mm [cod. 52.006]
- “Stylo” showerhead 200 x 200 mm [cod. 52.103]
- “Zoe” showerhead 150 x 150 mm [cod. 52.104]

Options

- Satin finish [cod. 55.001]
- Mounting backplate [cod. 50.101]
- Foot rinse (faucet Stella & “Loft” or “Flavia” showerhead) [cod. 54.001]
- Telephone showerhead [cod. 53.001]
- Water service output 1/2” [cod. 56.001]

Cod: 03.057

Name: Shower archway Rubino S3

Description: Shower archway with a circular cross section with three diffusers

Standard Configuration

1 “Evo” showerhead dia 200 - 2 lateral showerheads “Loft”

Showerhead: “Evo” showerhead 200 x 200 mm [cod. 52.101]

Mounting: Bottom plate dia. 170 mm [cod. 50.004]

Measurements: Body dia. 60 mm Height h 220 cm

Archway width 120cm

Materials: AISI 316L stainless steel

Finish: Glossy, mirror-like manual polishing, “nautical” level quality

Hook-up: Water input 1/2” to the left

Photocells columns

Extra: Alternative: single central diffuser.

RUBINO S₃



INOX TYLE *v. EN.*

INOXSTYLE S.R.L.

*Offices: Piazza Romboni, 20 - 55041 Camaiore
(LU) - Italy*

Tel. +39 0584 1716108

Fax. +39 0584 1712028

email: info@inoxstyle.com

[http:// www.inoxstyle.com](http://www.inoxstyle.com)

Showrooms and exhibition:

Via Sarzanese, 111 - 55045 Pietrasanta (LU)

Catalogo INOXSTYLE
versione inglese

Progetto a cura di
Salmoria&Associati - Firenze

Art & Foto di Michele Monasta
Set a cura di Elena Bianchini